

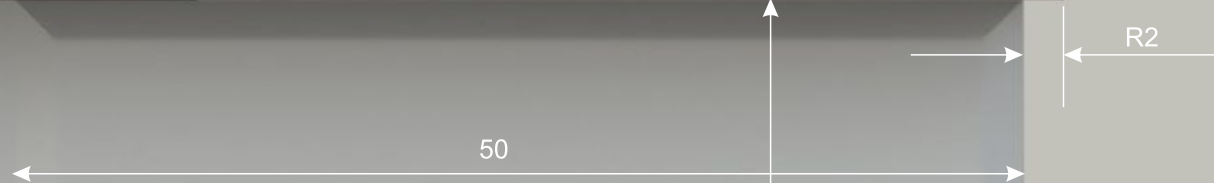

bok: 290 x 954

noga: 50x50
wys. 954



dachkant
2mm szer.
1mm gł.

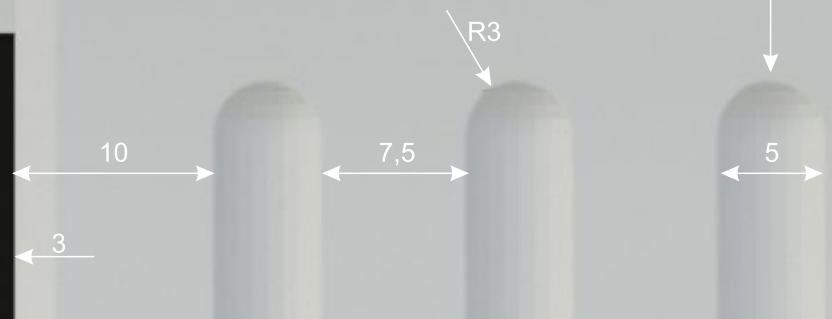
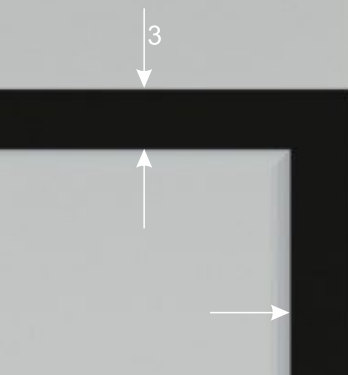

wieniec bok:

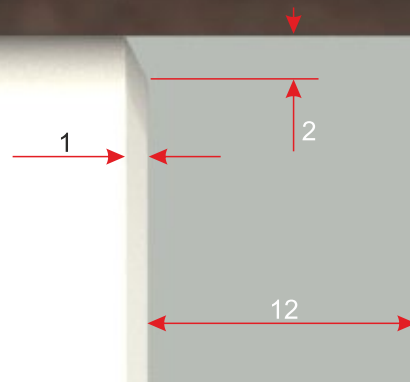

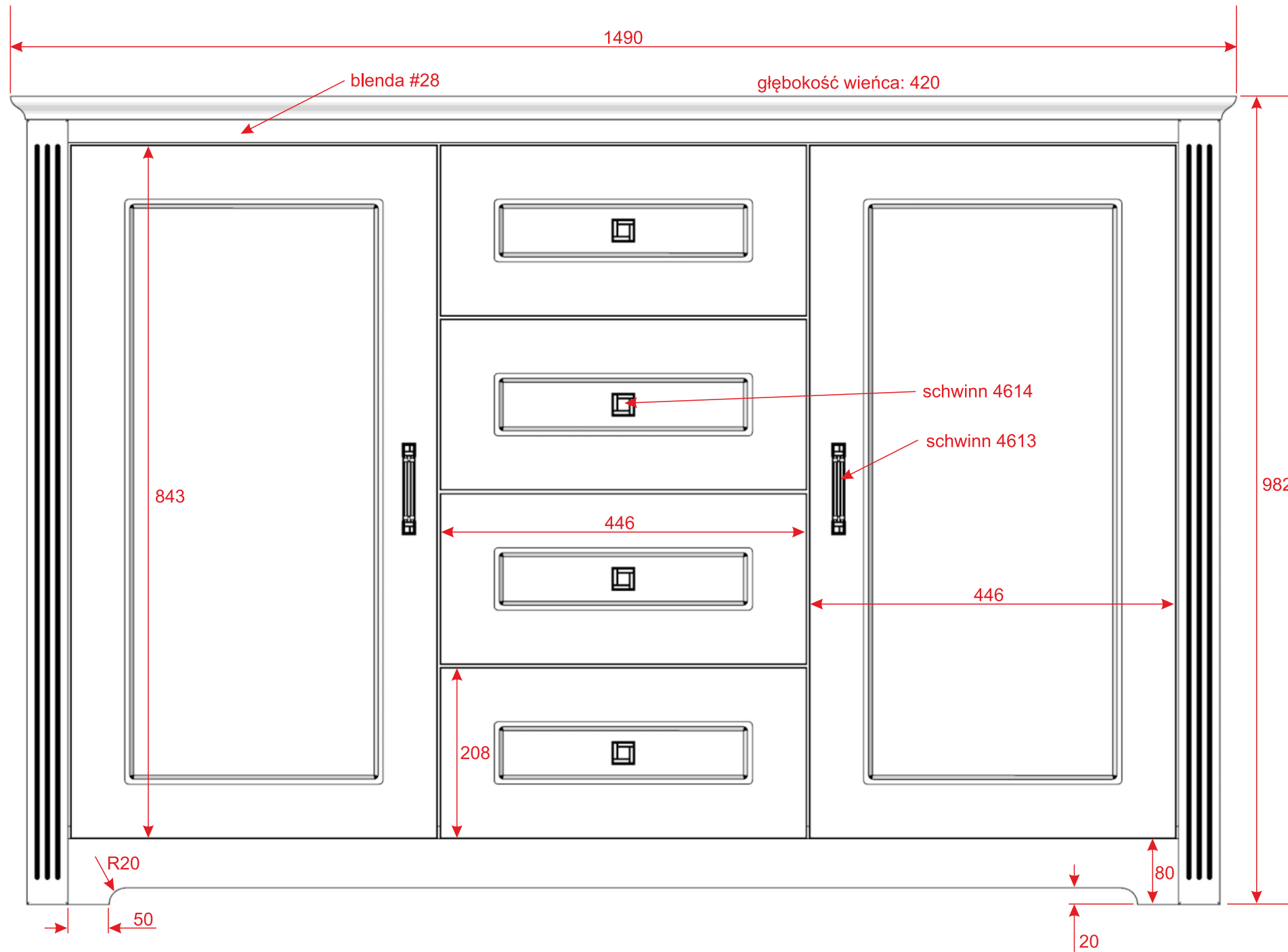



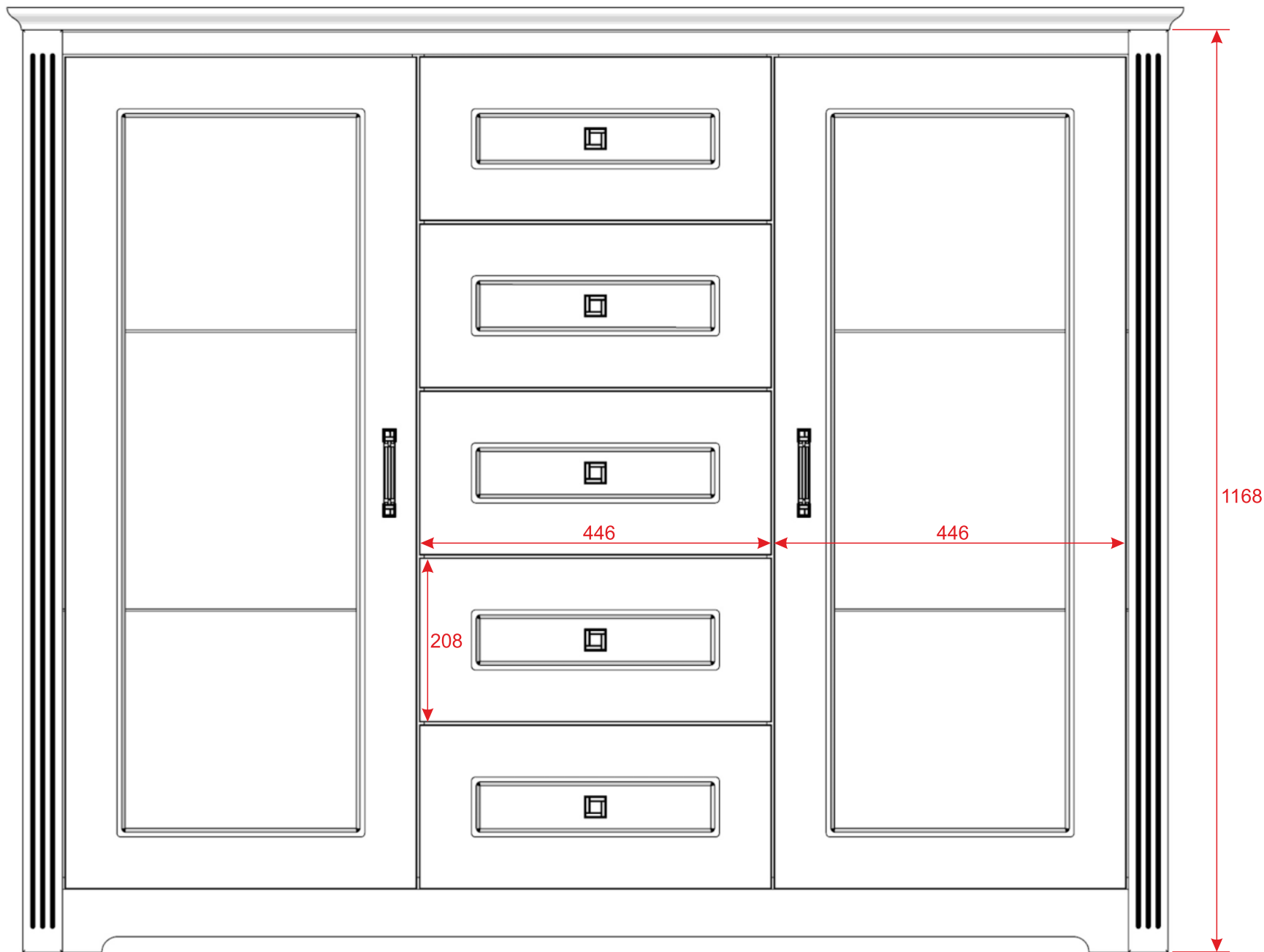



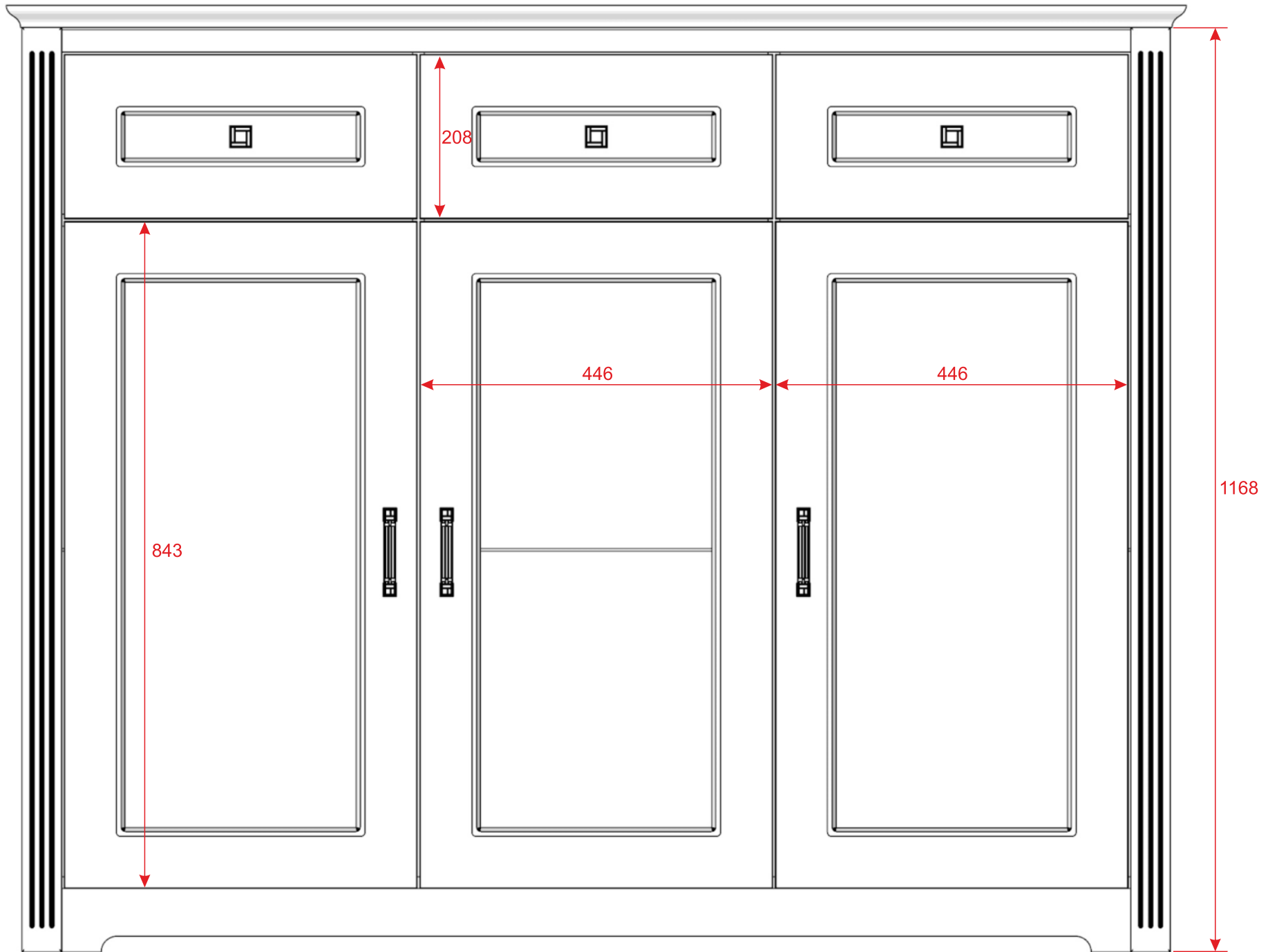



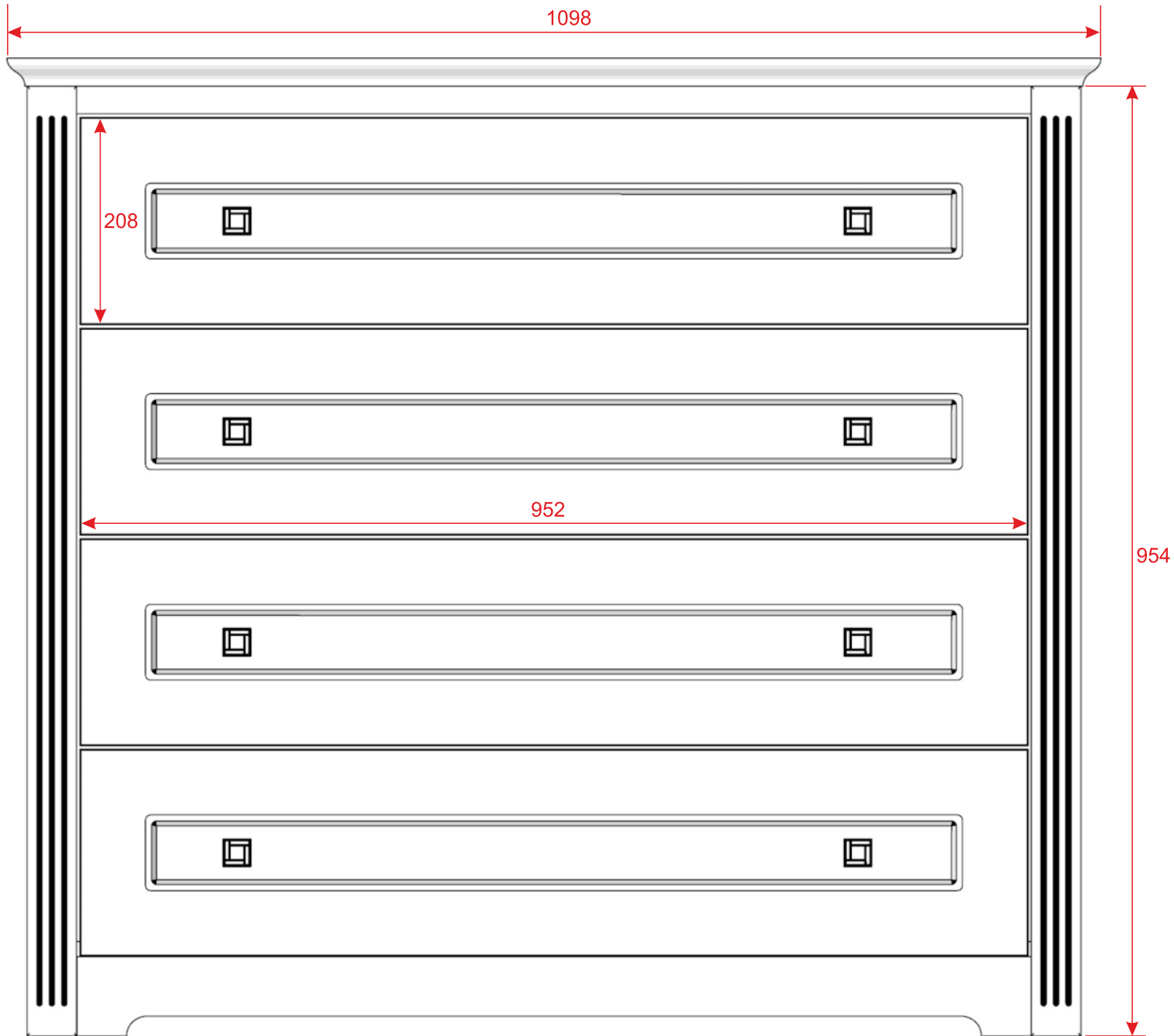



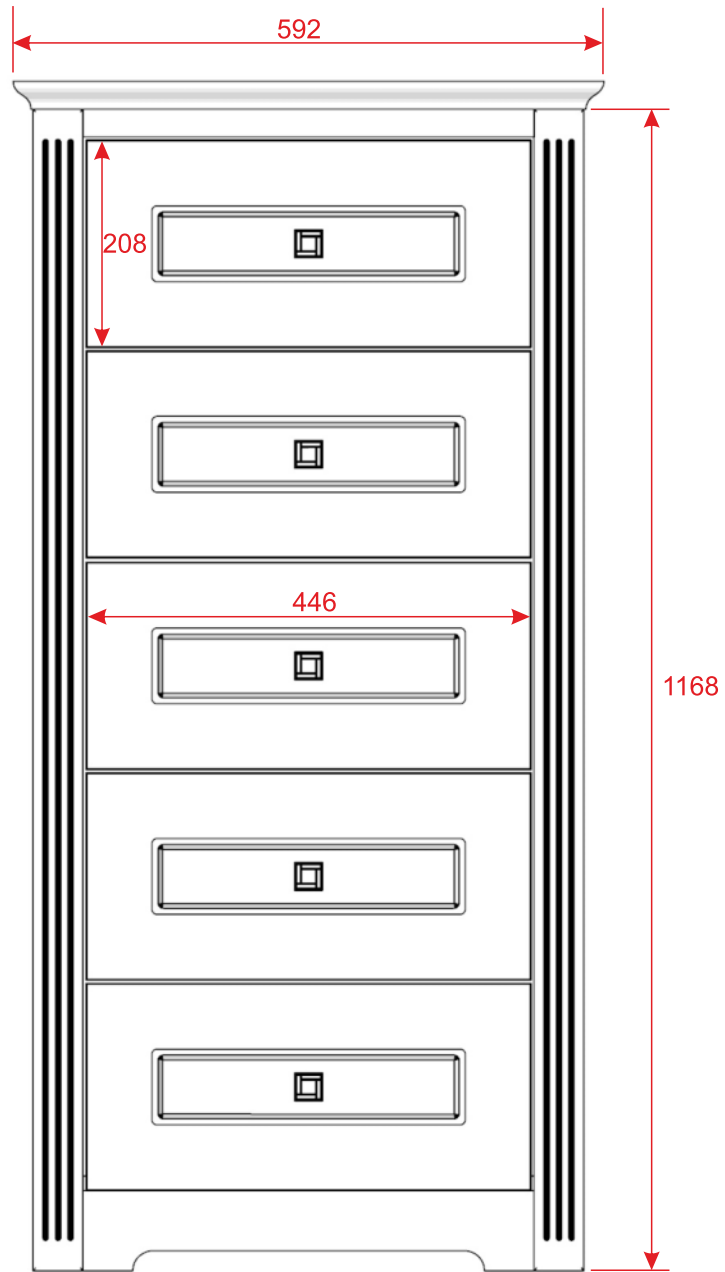



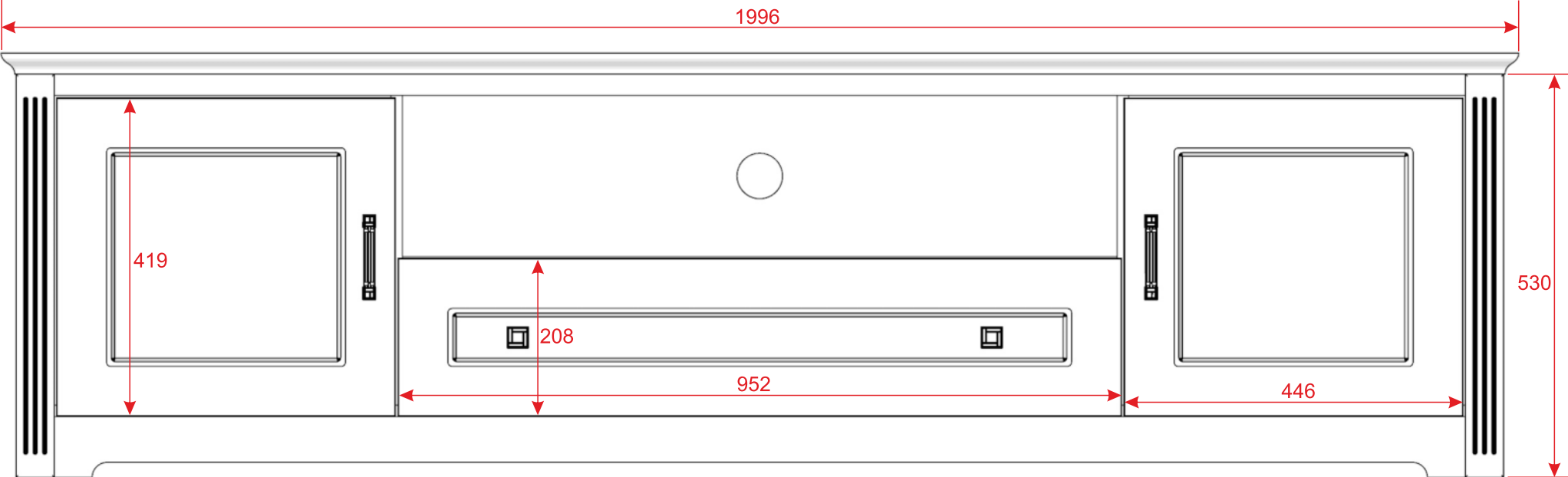



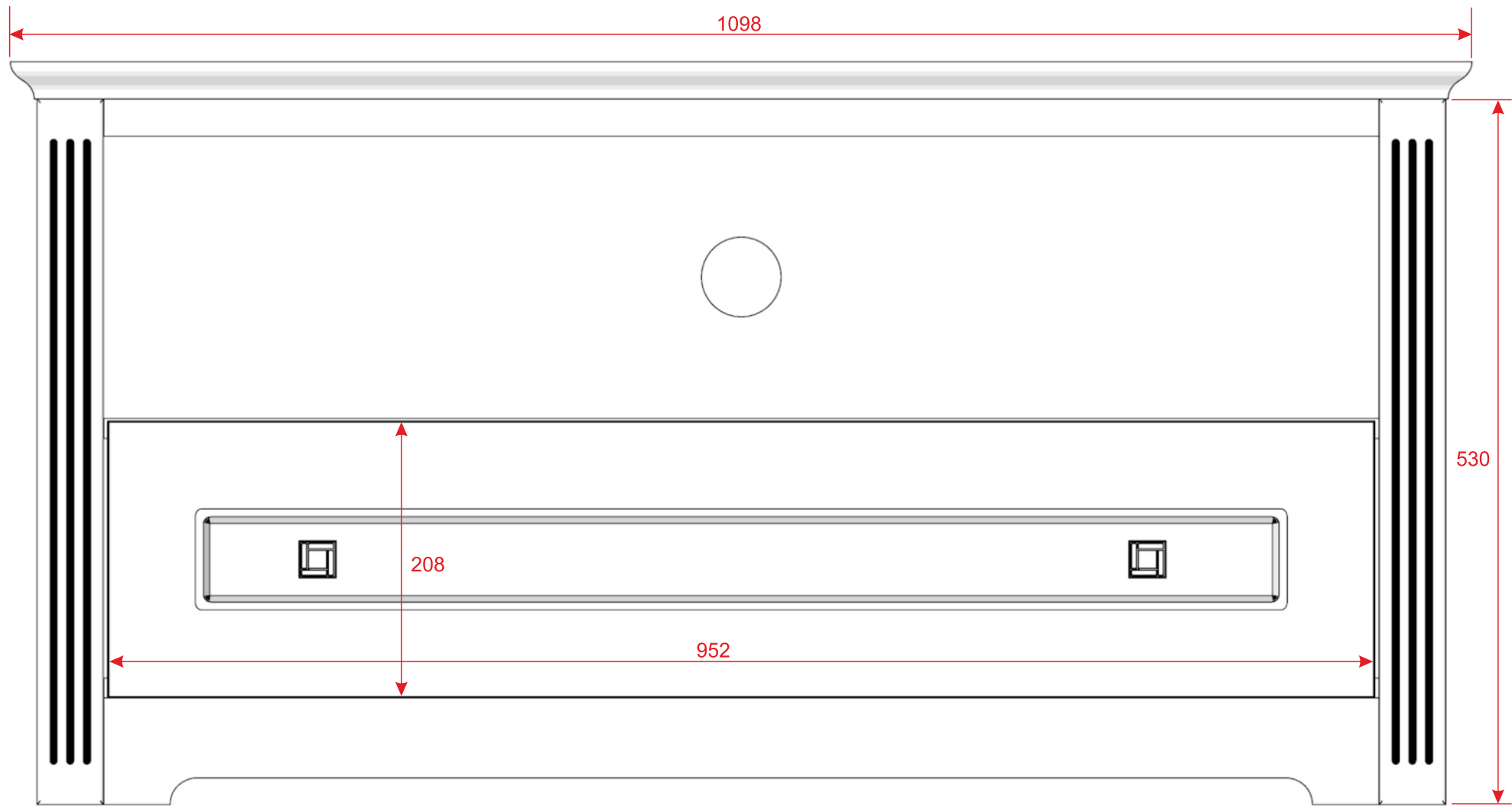



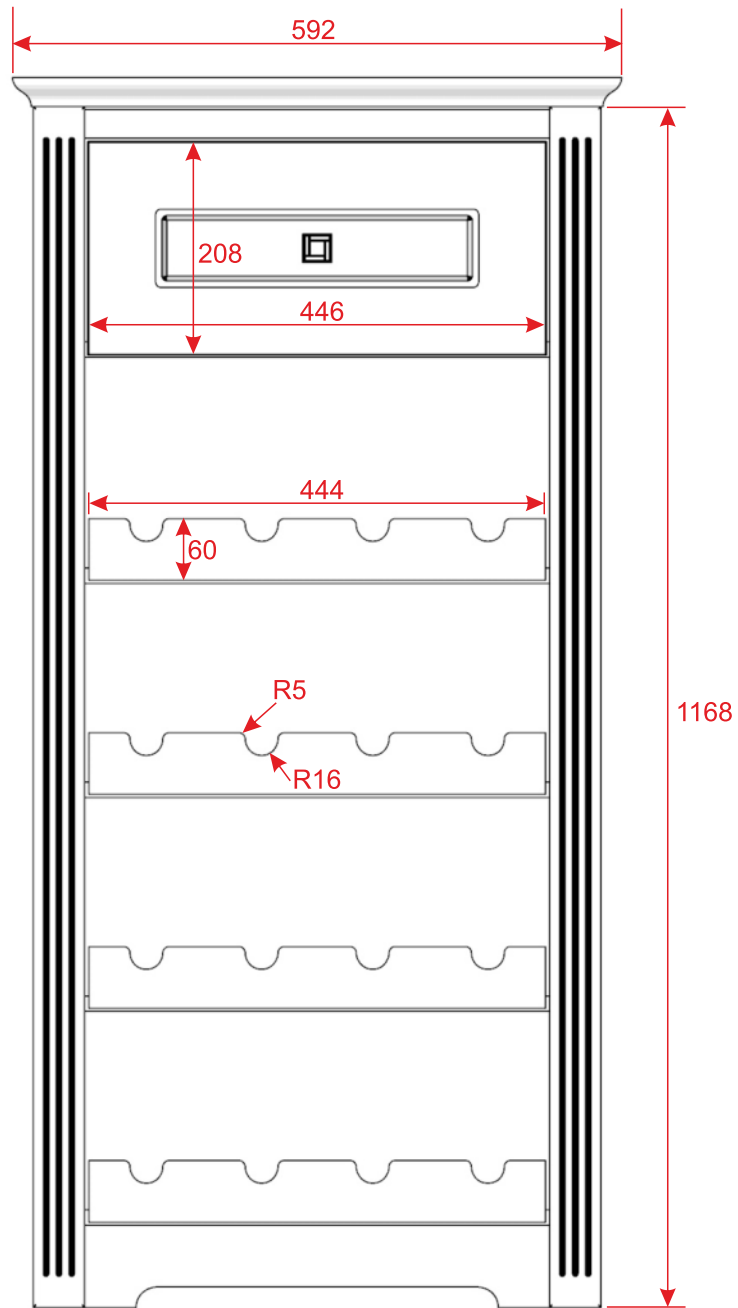



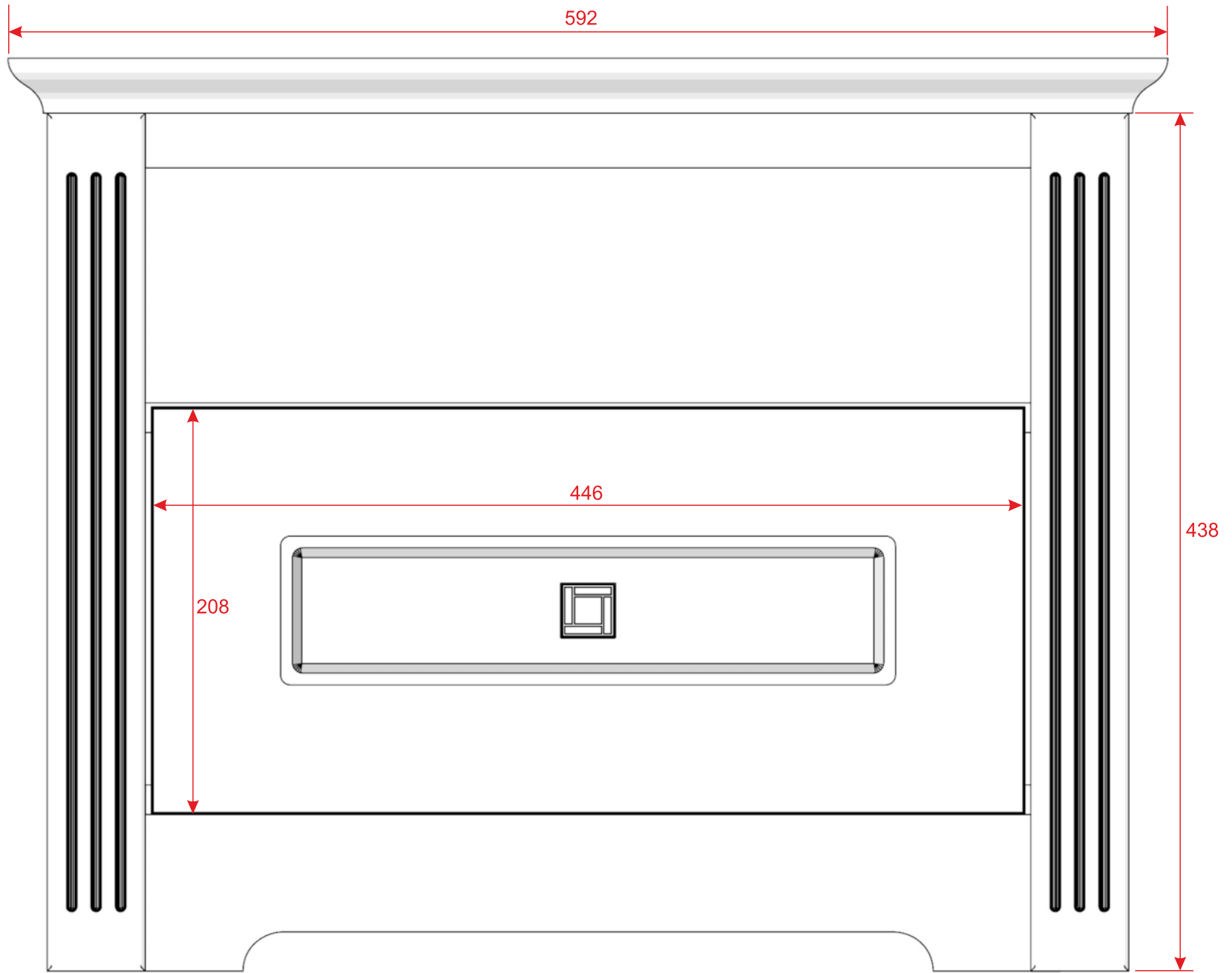



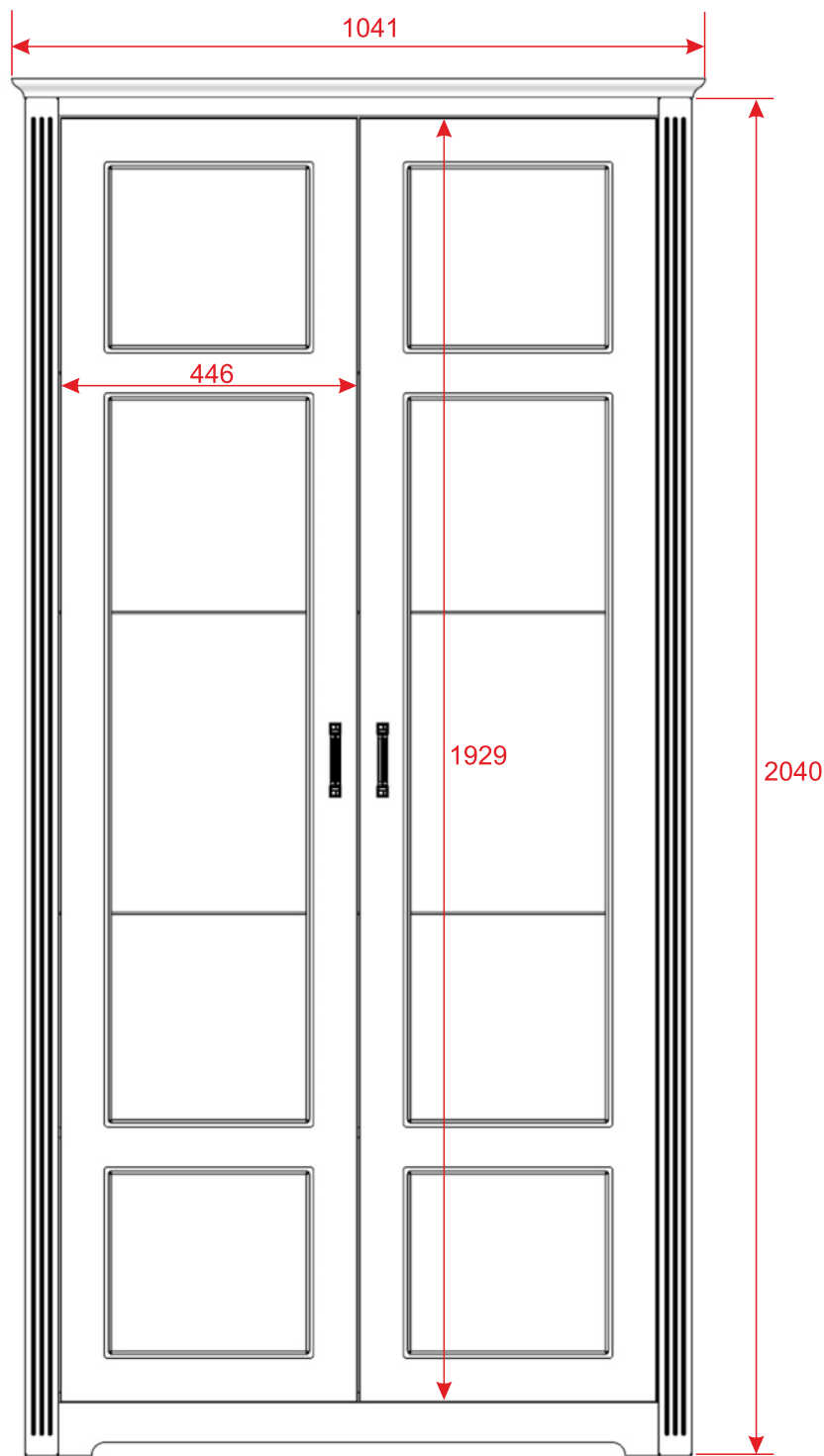

1041

446

1929

2040



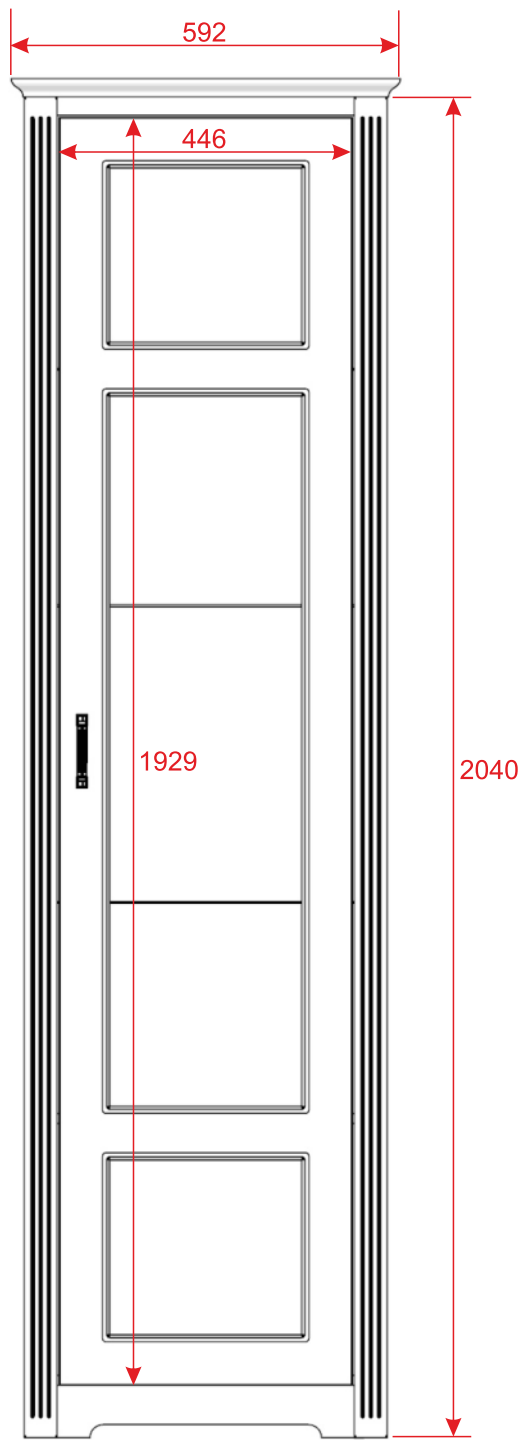



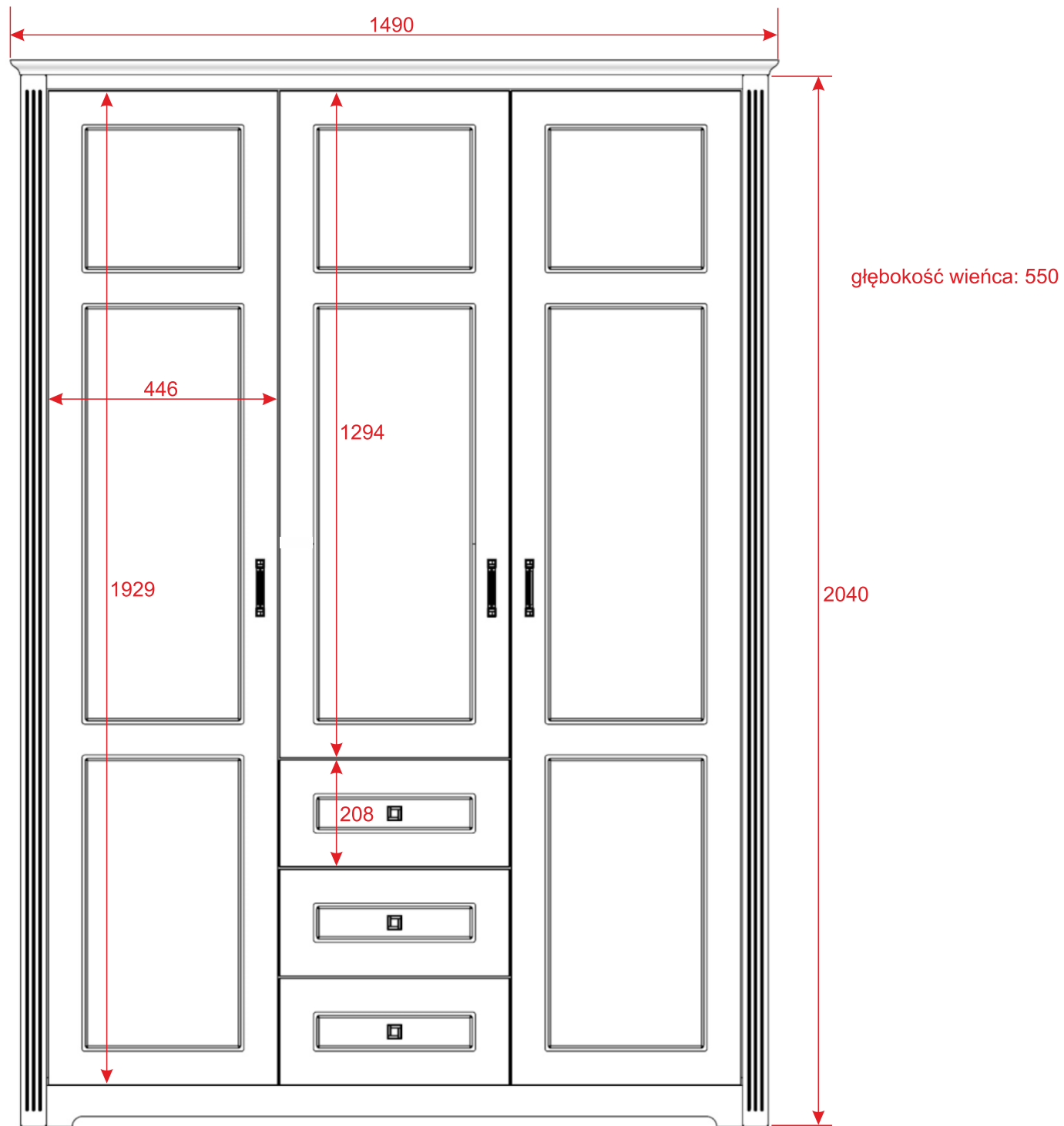



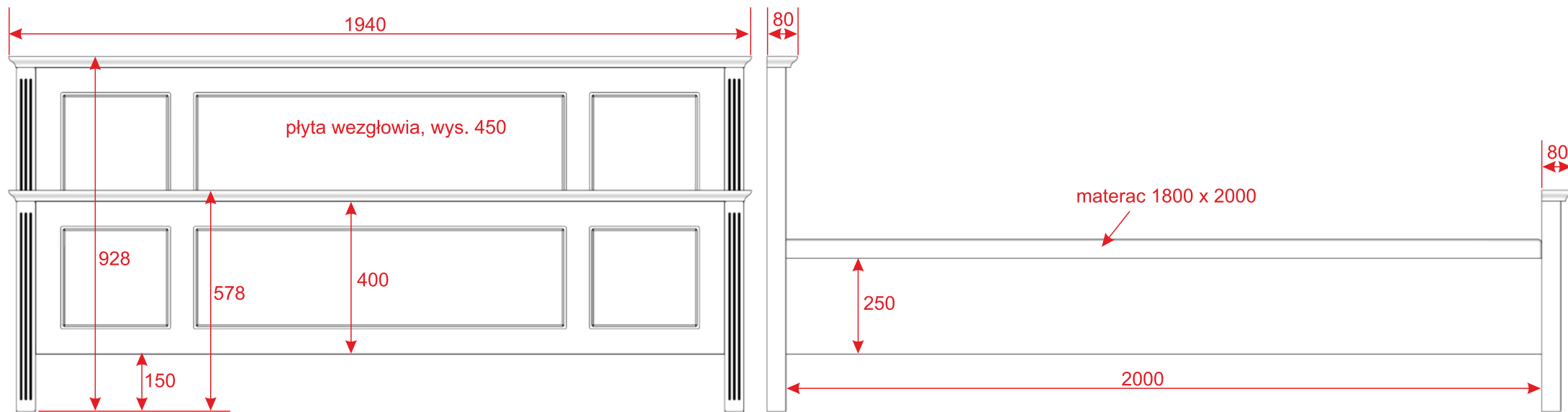



głębokość wieńca: 48

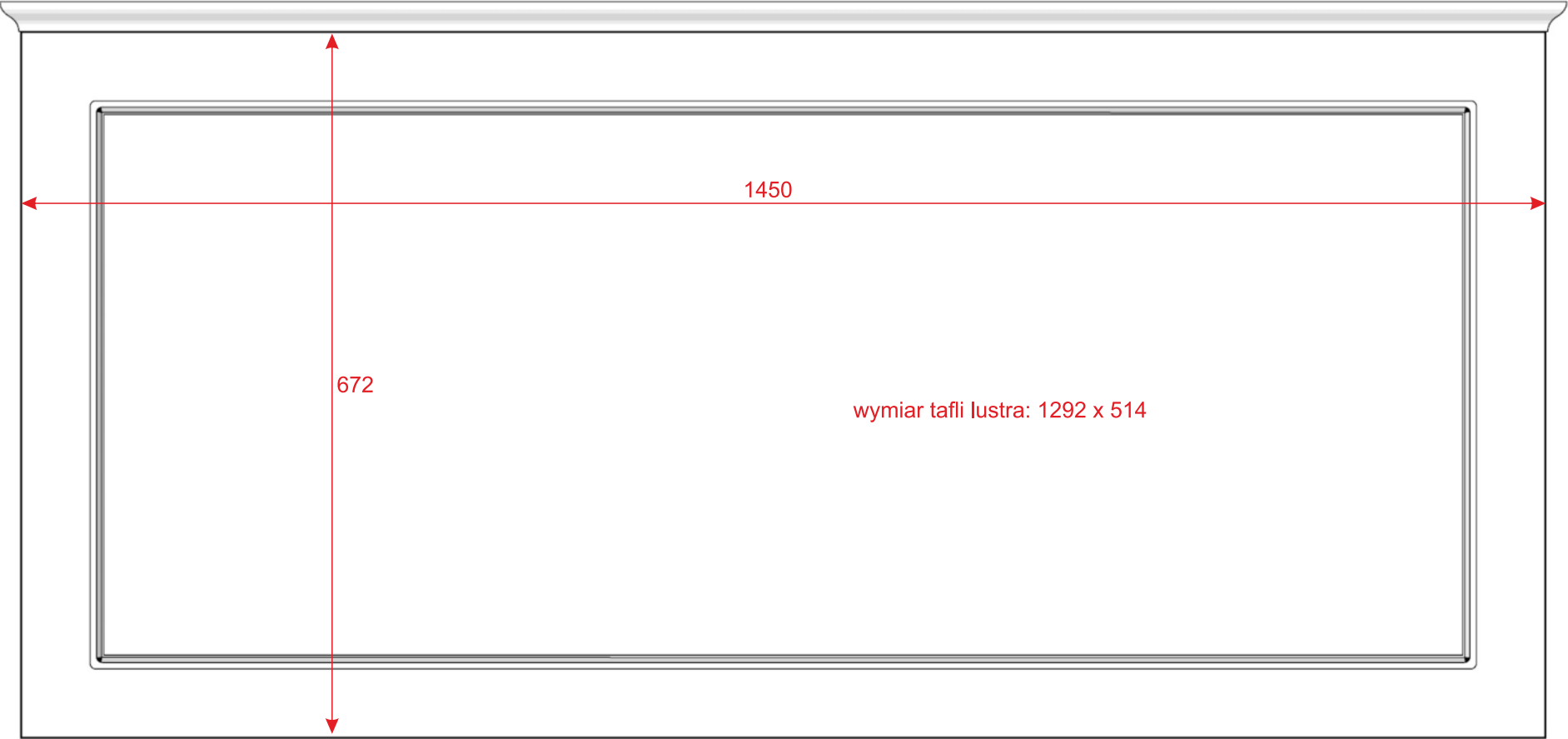

1450

672

wymiar tafli lustra: 1292 x 514



R50

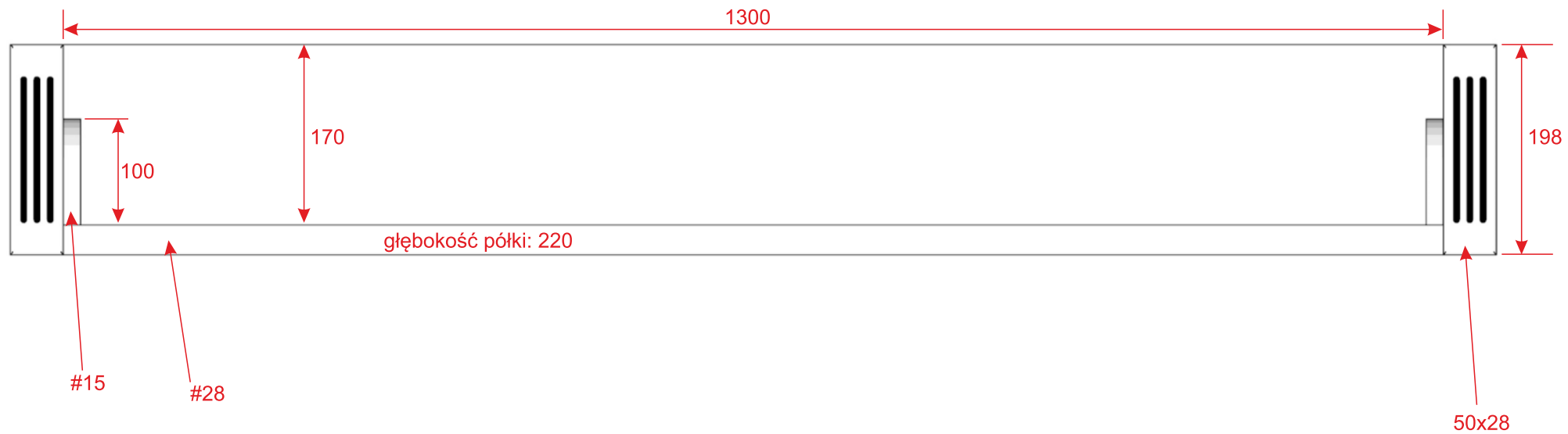



blat stołu: 1600 x 28 x 900

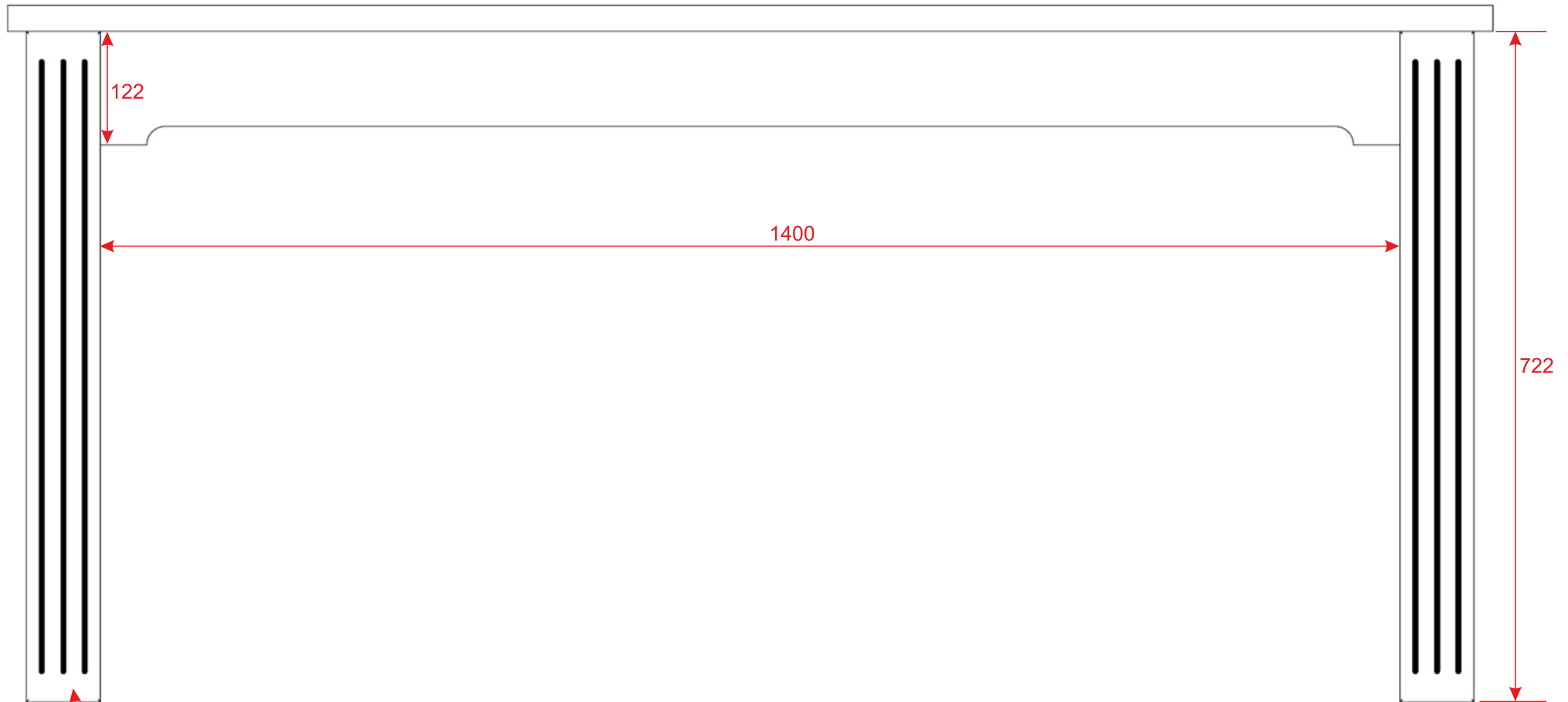

80 x 80 (nie koniecznie z frezem)



blat stolika: 1100 x 28 x 600

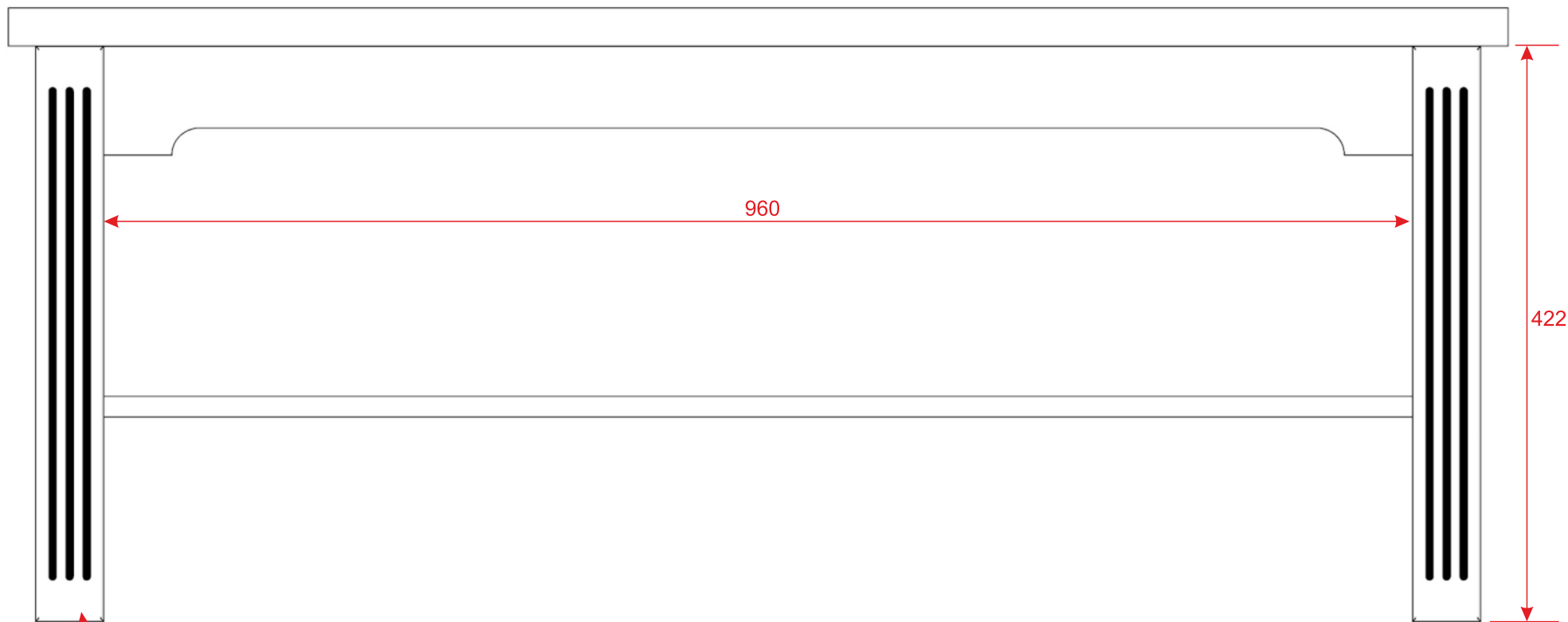

50 x 50