

SHIFT / SZAFKA_ 2D_1SZ

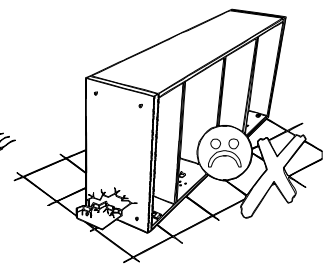

SHIFT / SZAFKA_2D_1SZ

PROSIMY O UWAGNE PRZECZYTANIE PRZED ROZPOCZĘCIEM MONTAŻU

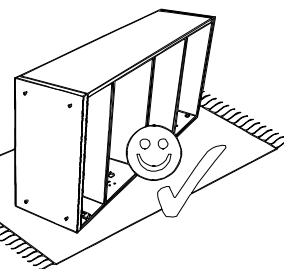
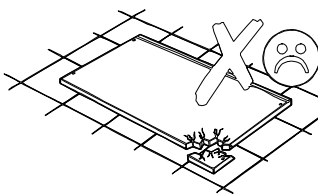
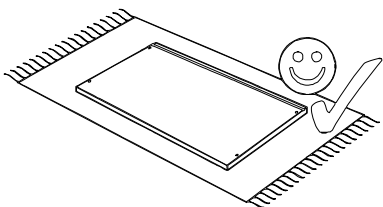
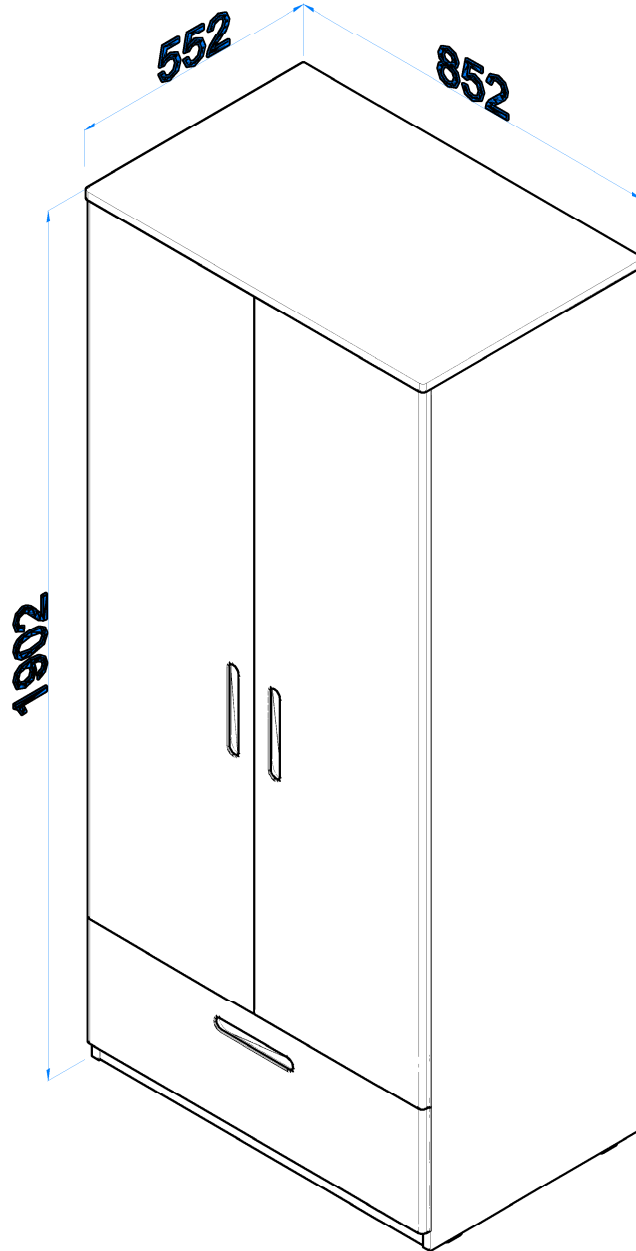
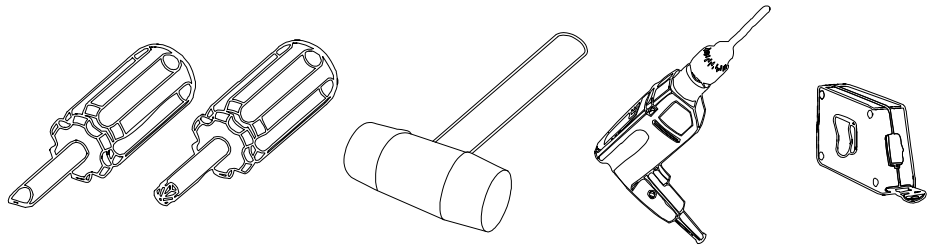
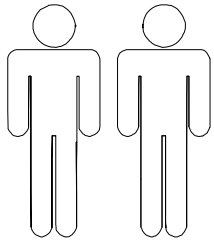





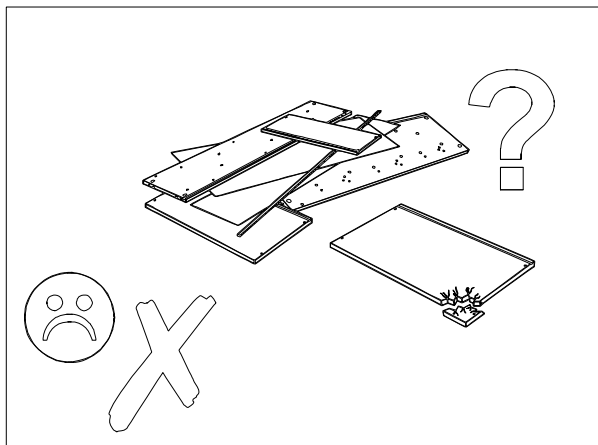
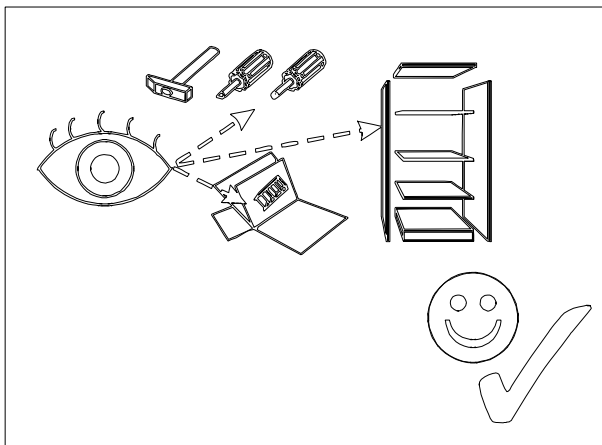
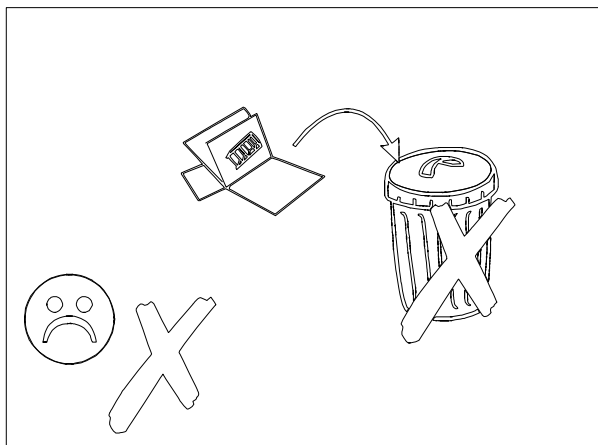
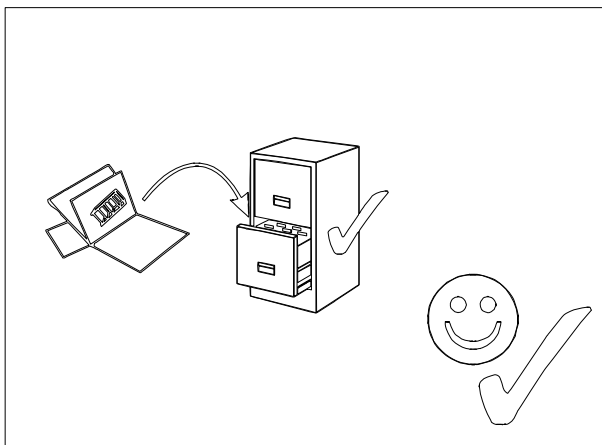
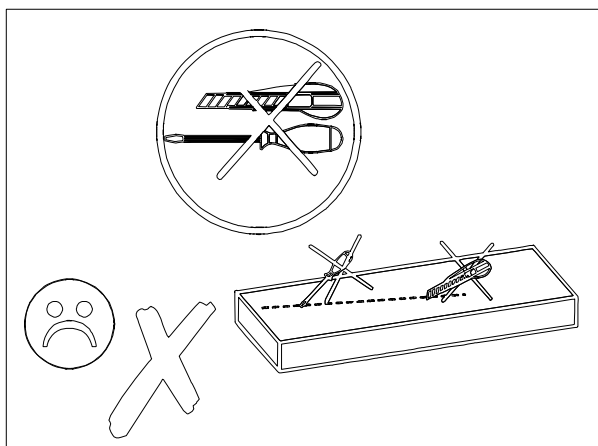
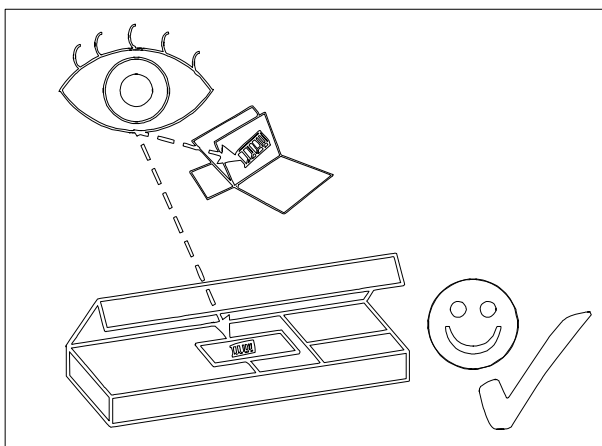

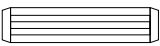

- Przed rozpoczęciem montażu mebli prosimy o szczegółowe zapoznanie się z instrukcją montażu i wykazem elementów wchodzących w skład danej paczki. W przypadku jakichkolwiek wątpliwości co do montażu zakupionych elementów prosimy o kontakt z salonem sprzedaży.
- W przypadku stwierdzenia jakichkolwiek braków w czasie rozpakowywania elementów, prosimy o skierowanie się do salonu z dowodem zakupu tegoż mebla oraz kartką kontrolną - etykietą z paczki, w której znajduje się dany element.
- W przypadku stwierdzenia uszkodzeń mechanicznych prosimy o nie montowanie mebla, udanie się do salonu z dowodem zakupu oraz kompletną paczką z oryginalnym (nieuszkodzonym) opakowaniem danego elementu celem potwierdzenia, iż uszkodzenia nie powstały wskutek nieprawidłowego montażu lub rozpakowania.
- Elementy uszkodzone zmontowane, noszące znamiona rozpoczętego montażu lub dostarczone bez oryginalnego opakowania nie podlegają reklamacji.
- Wszystkie uszkodzenia powstałe w wyniku nieprawidłowego montażu mebli przez klienta są traktowane jako reklamacje odpłatne.
- Zgłoszenia reklamacji należy dokonywać w formie pisemnej z wyszczególnieniem: opisu uszkodzenia, data i numer dowodu zakupu, numeru pakowacza (znajdującego się na etykiecie kontrolnej).
- Zarówno opakowania plastikowe, jak i okucia trzymać w miejscu niedostępnym dla niemowląt i dzieci.
- Wszystkie połączenia powinny być odpowiednio dokręcone



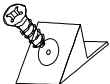

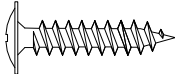
READ BEFORE ASSEMBLY

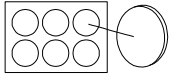
- Please read entirely Included Instruction manual and review packaged accessories according to diagram before assembling your furniture. Should you need further assistance with assembly, please contact your original place of purchase.
- Should you find missing parts or accessories during unpacking, please contact your original place of purchase. Have your original sales receipt and particular box control label ready.
- Should you find your furniture mechanically damaged, please do not continue with assembly. Return the product to original place of purchase along with all packaging materials in order to verify, that damages were caused during shipment and to improper assembly or unpacking.
- Any assembled and partially assembled units returned without original packaging will not be warranted.
- Any claims due to damages arisen during improper assembly by end user, or a third party will be covered for a fee.
- All claims must be submitted in writing only including the following: name, address, contact, detailed description of damages, proof of purchase and box control label (which includes ID number of packing person).

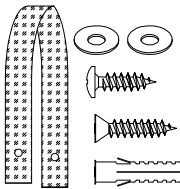

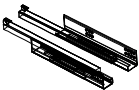
SHIFT / SZAFKA_2D_1SZ

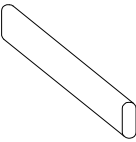
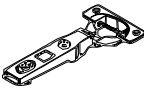
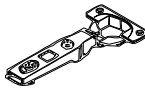
ZESTAW AKCESORIÓW (PACZKA) SHIFT / SZAFKA_2D_1SZ										SPR.	
											
K1	KOLEK Ø 8 52-SZT.	K2	KOLEK POD PÓŁKI 16-SZT.	T1	TRZPIEŃ 24-SZT.	M1	MIMOŚRÓD 24-SZT.	G1	GWOŹDZIK 33-SZT.	E1	WZMOCNIENIE DO PLECÓW 22-SZT.
											
W1	EURO WKREŃ 8-SZT.	W3	WKREŃ 3.5x16 14-SZT.	W4	WKREŃ 4x16 Z ŁBEM POKŁADKĄ 6-SZT.	Ł1	ŁACZNIK DO PLECÓW 8-SZT.	S1	ŚLIZG 5-SZT.	Z1	ZAŚLEPKA 14-SZT.
											
Y1	UCHWYT POD DRAŻEK CHROM SZT.2	ZESTAW Z INSTR. ZAPOBIEGAJĄCY WYWRÓCENIU 1-KPL.									

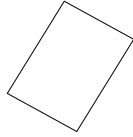
AKCESORIA DODATKOWE SHIFT / SZAFKA_2D_1SZ										SPR.	
											
P1	PROWADNICA BLUM 360-MM. 551H3601B 1-KPL.	Z2	ZAŚLEPKA FRONTU 3-SZT.	Y2	DRAŻEK CHROM L-395MM. 1-SZT.	B1	ZAWIAS BLUM CLIP TOP 71B3550 4-SZT.	B2	ZAWIAS BLUM CLIP TOP 71T3550 2-SZT.	O1	PROWADNIK BLUM H-0 17SL810 Z EURO 6-KPL.
											
X1	LISTWA DO PLECÓW 310-MM 1-SZT.	INSTRUKCJA									

SHIFT / SZAFKA_2D_1SZ

NR.	NAZWA	ELENTY WYM.	SZT.	WARSTWA	KARTON #3	SPRAWDZIŁ
1A	front_szufl	#18x846x269	1	2A	1 WYM.	NR. PAKOWACZA
2A	front_pl	#18x1569x421	1	3A	1610x600x60 1/2	
3A	front_pl	#18x1569x421	1	1A-4A		
4A	top	#18x852x552	1			
1B	bok_prawy	#16x1884x531	1	2B	1 WYM.	NR. PAKOWACZA
2B	bok_lewy	#16x1884x531	1	10B-11B-7B	2	
3B	bok_srodk	#16x1248x510	1	3B-8B	3	
4B	przepona_dolna	#16x818x510	1	4B-8B-8B	4	
5B	przepona_srod_1	#16x818x510	1	5B-8B	5	
6B	przepona_srod_2	#16x818x510	1	12B-13B		
7B	dno_szufl	#3x788x355	1	6B-9B-14B	6	
8B	polka	#16x491x401	4	1B	7	
9B	cokol	#16x818x40	1			
10B	plecy	#3x1850x415	1			
11B	plecy	#3x1850x415	1			
12B	bok_szufl	#16x350x200	1			
13B	bok_szufl	#16x350x200	1			
14B	tyl_szufl	#16x774x184	1			

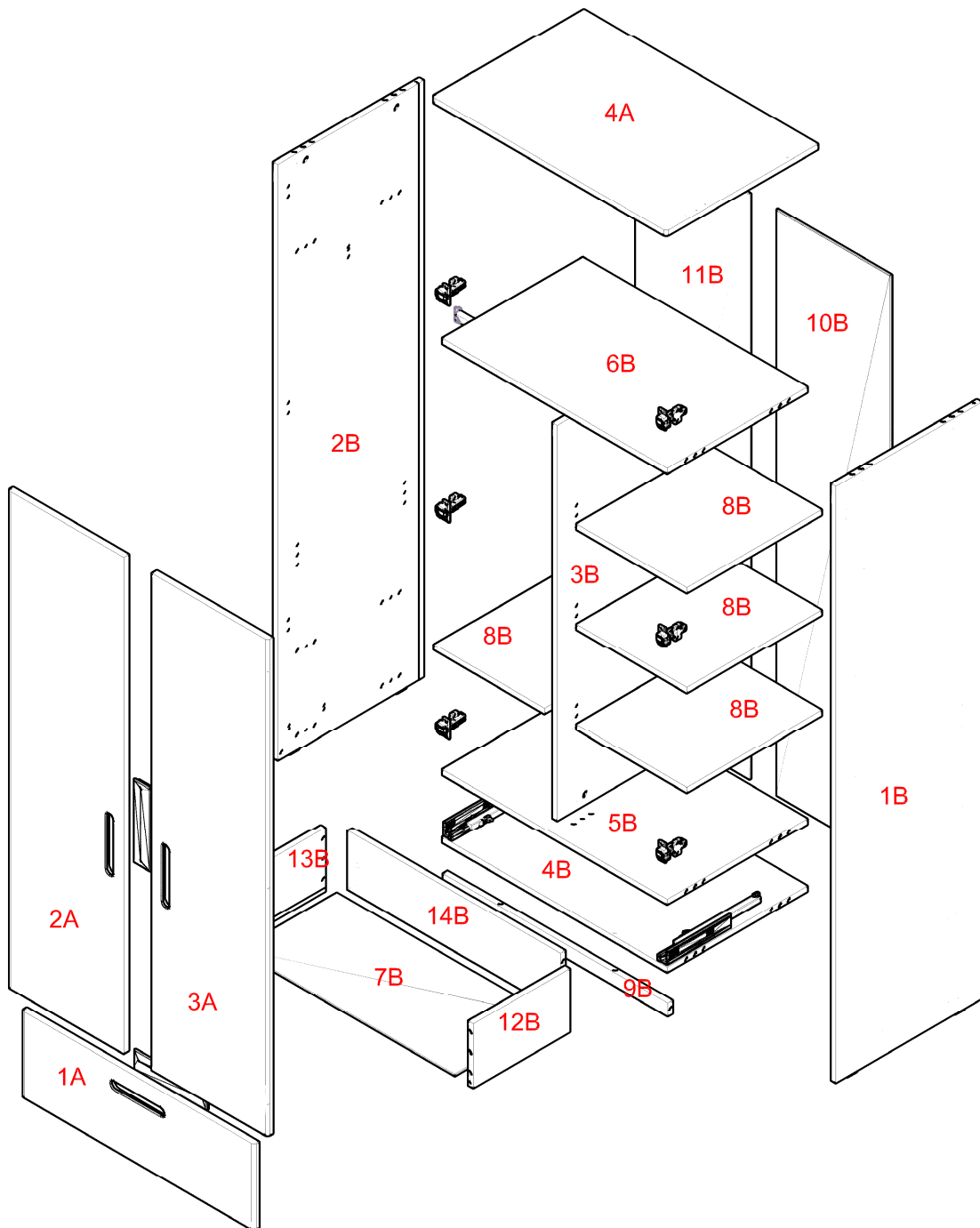

SHIFT / SZAFKA_2D_1SZ

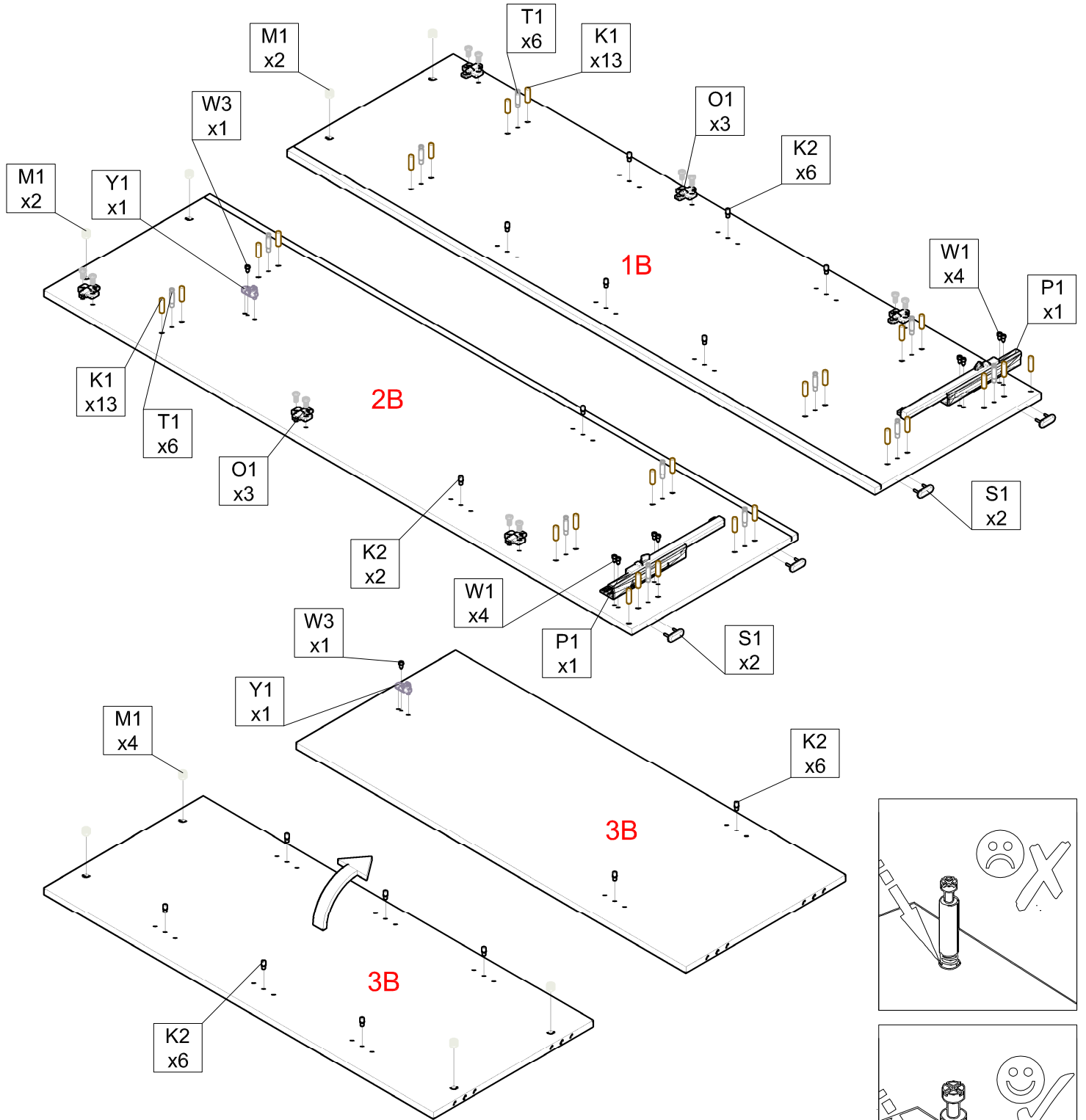
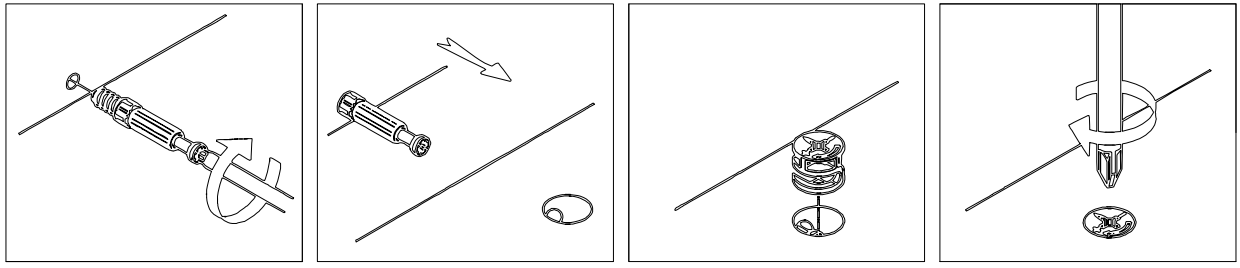

SHIFT / SZAFKA_2D_1SZ

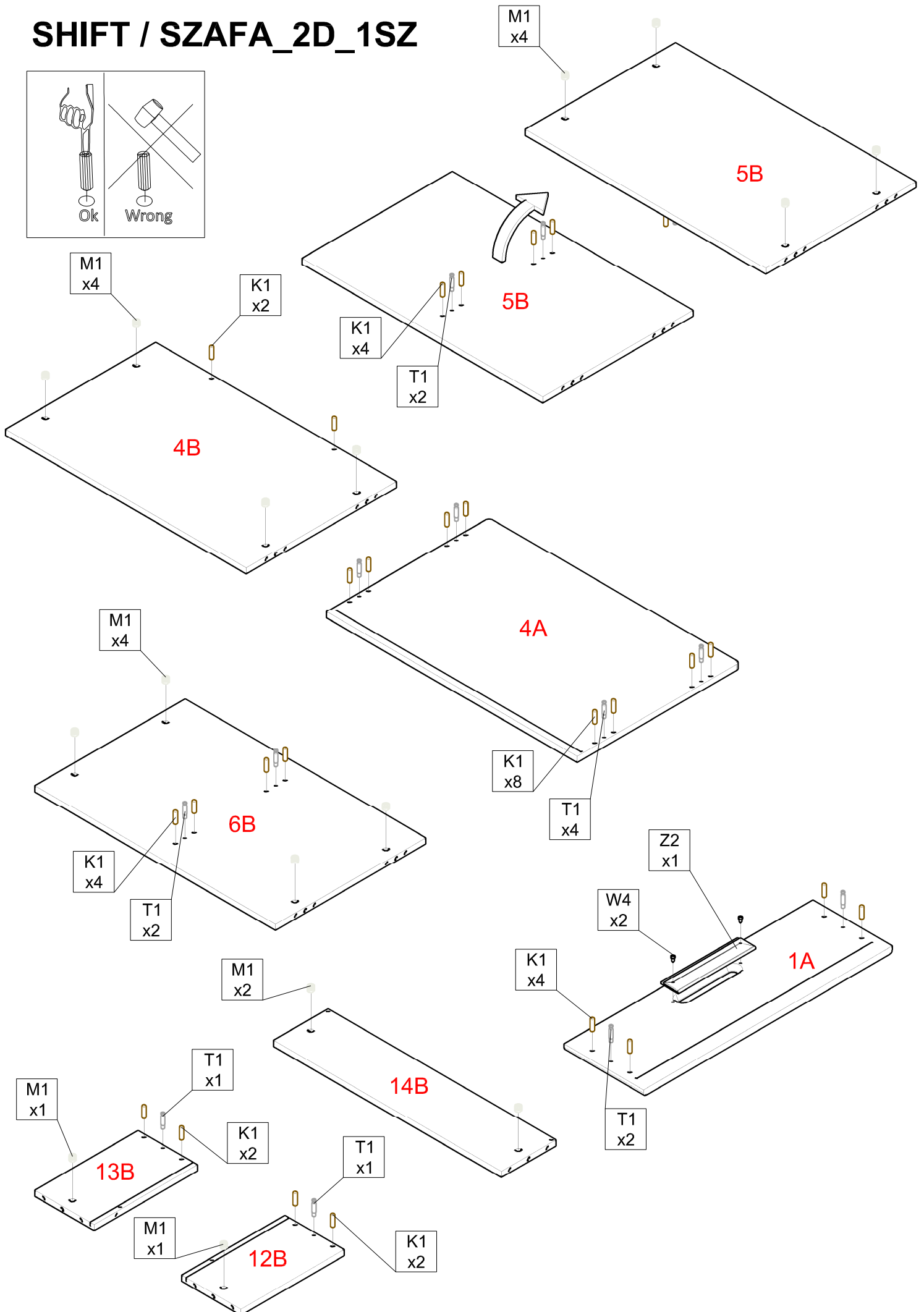
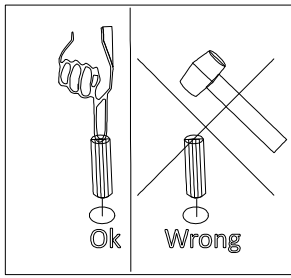

SHIFT / SZAFKA_2D_1SZ

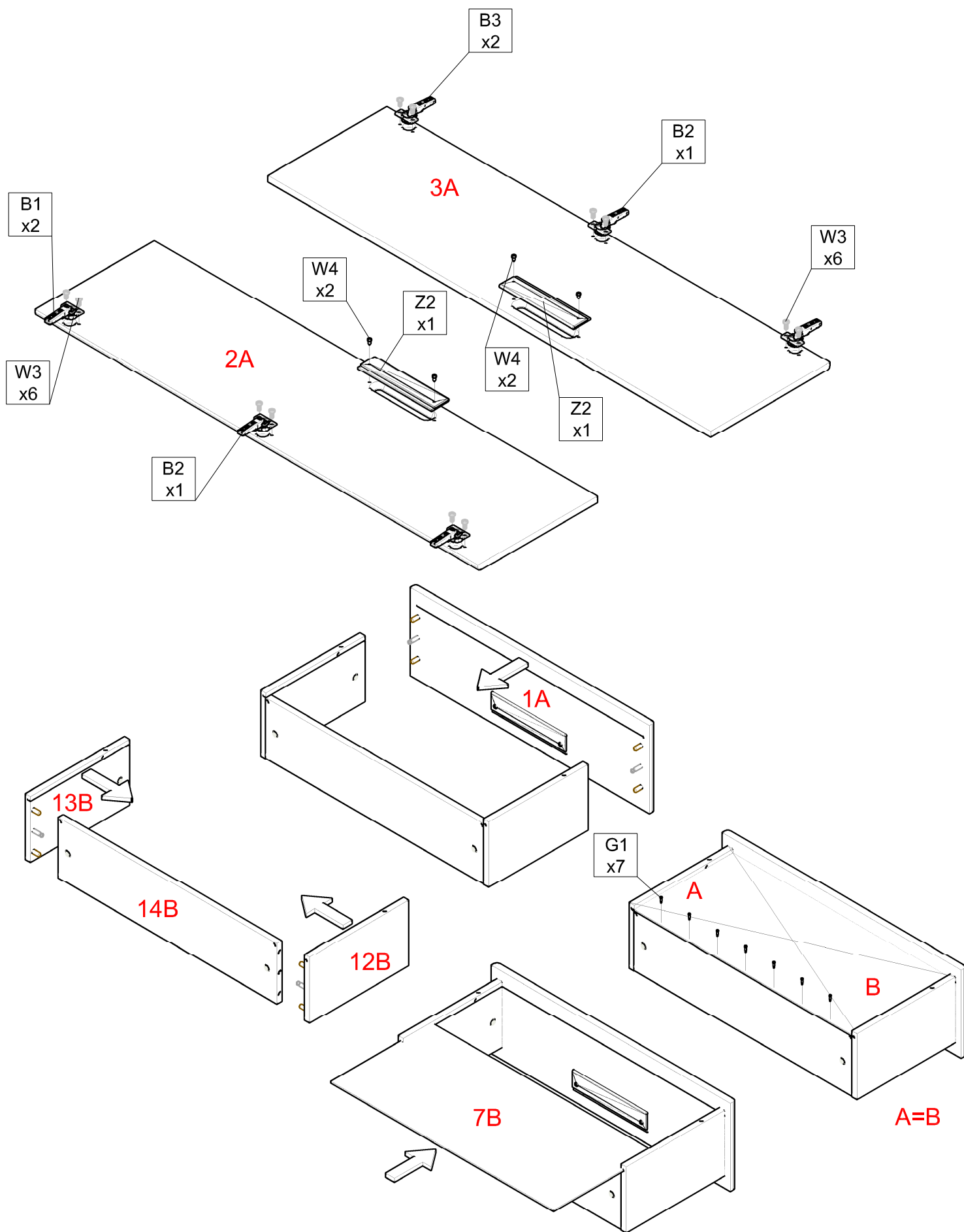

SHIFT / SZAFKA_2D_1SZ

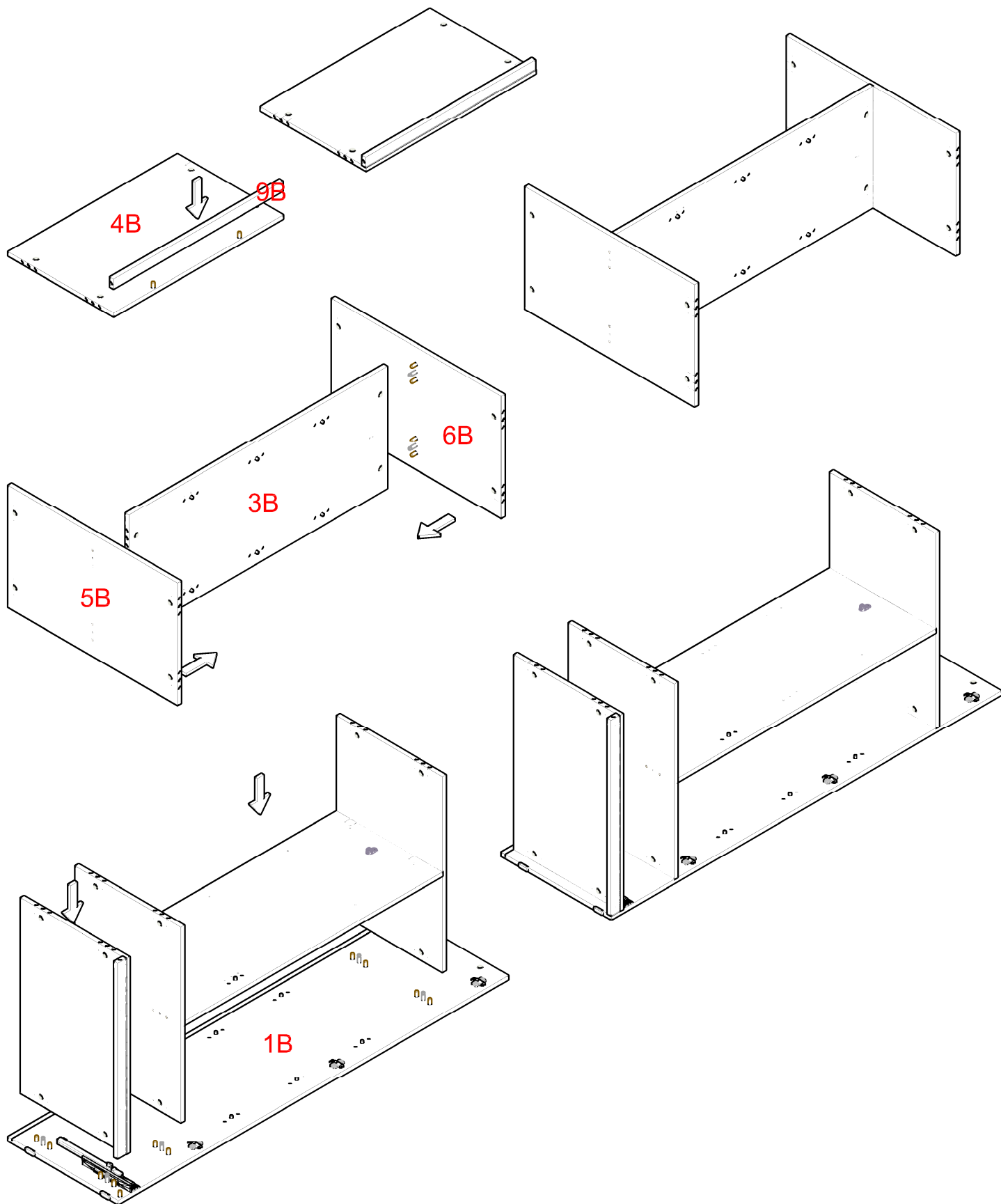

SHIFT / SZAFKA_2D_1SZ

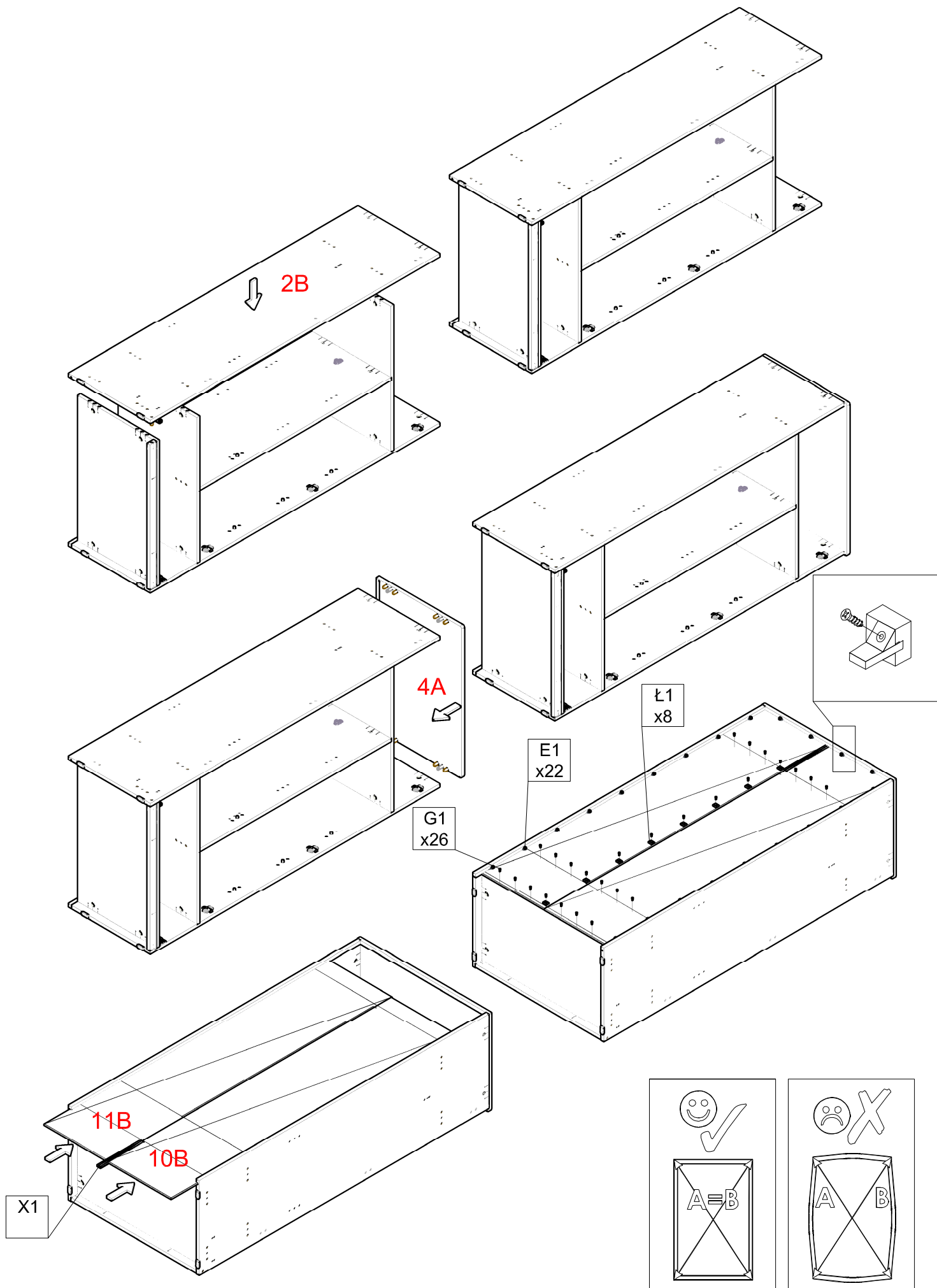

SHIFT / SZAFKA_2D_1SZ

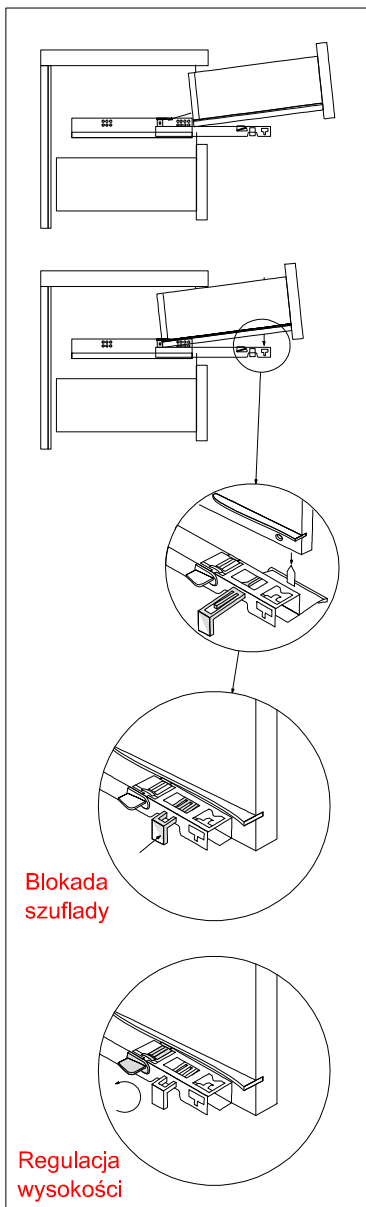

Blokada szuflady

Regulacja wysokości

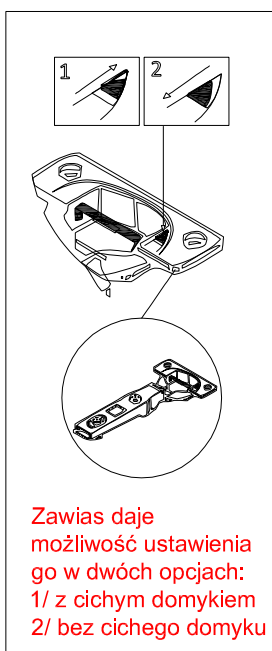

Zawias daje możliwość ustawienia go w dwóch opcjach:
1/ z cichym domykiem
2/ bez cichego domyku

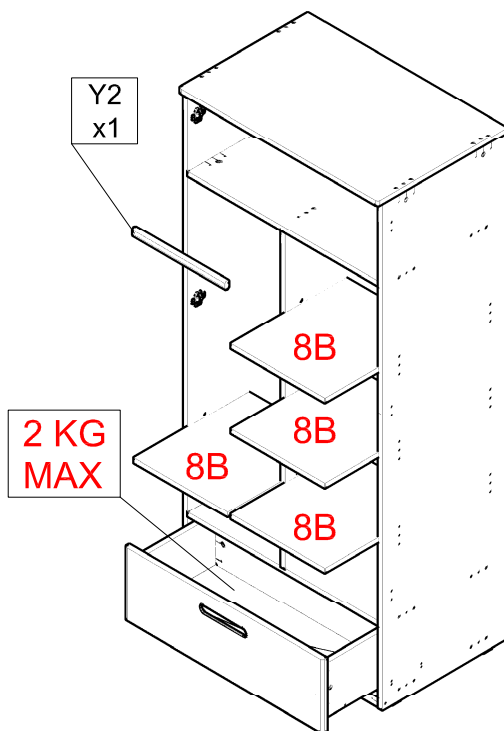

2 KG MAX

5 KG MAX

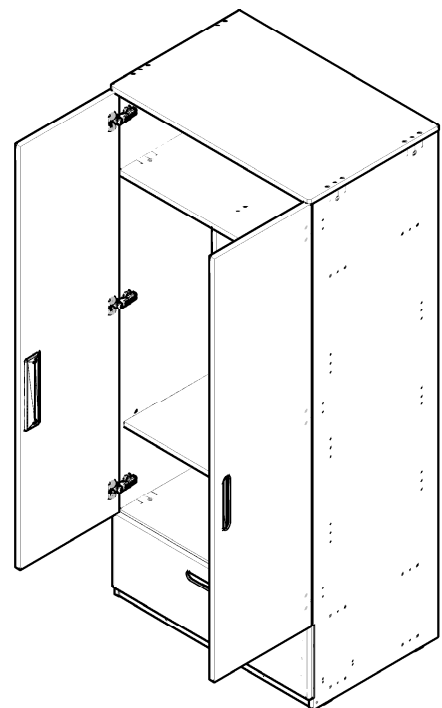

2A

3A

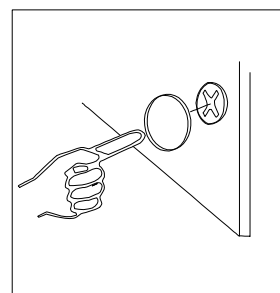

SHIFT / SZAFKA_2D_1SZ

