

QUADRATTO / KOMODA 4SZ 1D

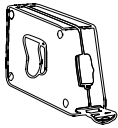
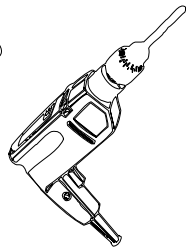
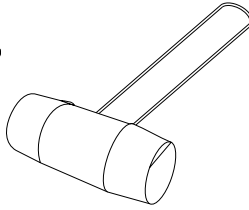
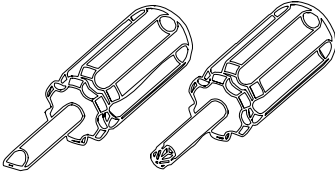
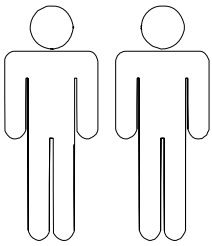

41

160

90

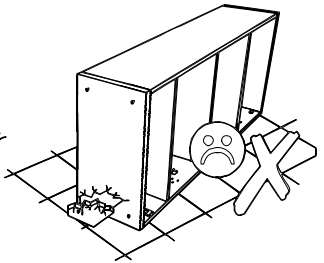
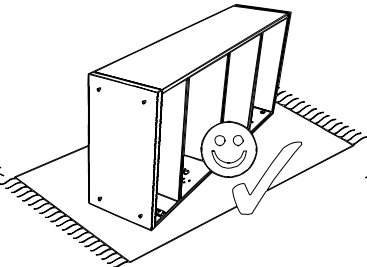
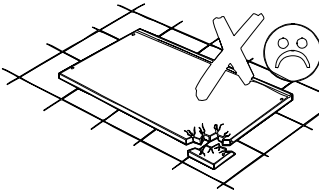
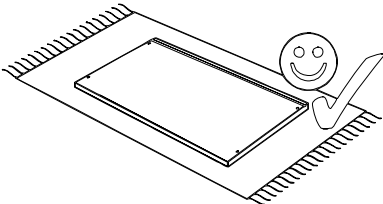

QUADRATTO / KOMODA 4SZ 1 D

PROSIMY O UWAGNE PRZECZYTANIE PRZED ROZPOCZĘCIEM MONTAŻU

- Przed rozpoczęciem montażu mebli prosimy o szczegółowe zapoznanie się z Instrukcją montażu i wykazem elementów wchodzących w skład danej paczki. W przypadku jakichkolwiek wątpliwości co do montażu zakupionych elementów prosimy o kontakt z salonem sprzedaży.
- W przypadku stwierdzenia jakichkolwiek braków w czasie rozpakowywania elementów, prosimy o skierowanie się do salonu z dowodem zakupu tegoż mebla oraz kartką kontrolną - etykietą z paczką, w której znajduje się dany element.
- W przypadku stwierdzenia uszkodzeń mechanicznych prosimy o nie montowanie mebla, udanie się do salonu z dowodem zakupu oraz kompletną paczką z oryginalnym (nieuszkodzonym) opakowaniem danego elementu celem potwierdzenia, iż uszkodzenia nie powstały wskutek nieprawidłowego montażu lub rozpakowania.
- Elementy uszkodzone zmontowane, noszące znamiona rozpoczętego montażu lub dostarczone bez oryginalnego opakowania nie podlegają reklamacji.
- Wszystkie uszkodzenia powstałe w wyniku nieprawidłowego montażu mebli przez klienta są traktowane jako reklamacje odpłatne.
- Zgłoszenia reklamacji należy dokonywać w formie pisemnej z wyszczególnieniem: opisu uszkodzenia, data i numer dowodu zakupu, numeru pakowacza (znajdującego się na etykiecie kontrolnej).
- Zarówno opakowania plastikowe, jak i okucia trzymać w miejscu niedostępnym dla niemowląt i dzieci.
- Wszystkie połączenia powinny być odpowiednio dokręcone

READ BEFORE ASSEMBLY

- Please read entirely Included Instruction manual and review packaged accessories according to diagram before assembling your furniture. Should you need further assistance with assembly, please contact your original place of purchase.
- Should you find missing parts or accessories during unpacking, please contact your original place of purchase. Have your original sales receipt and particular box control label ready.
- Should you find your furniture mechanically damaged, please do not continue with assembly. Return the product to original place of purchase along with all packaging materials in order to verify, that damages were caused during shipment and to improper assembly or unpacking.
- Any assembled and partially assembled units returned without original packaging will not be warranted.
- Any claims due to damages arisen during improper assembly by end user, or a third party will be covered for a fee.
- All claims must be submitted in writing only including the following: name, address, contact, detailed description of damages, proof of purchase and box control label (which includes ID number of packing person).

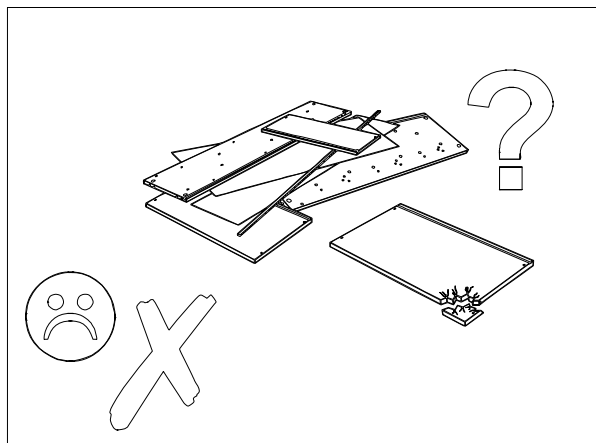
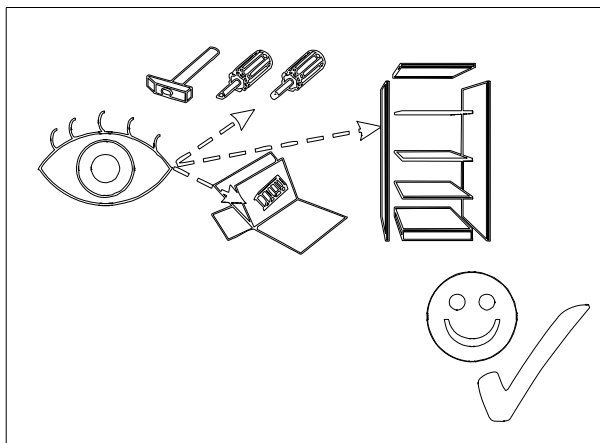
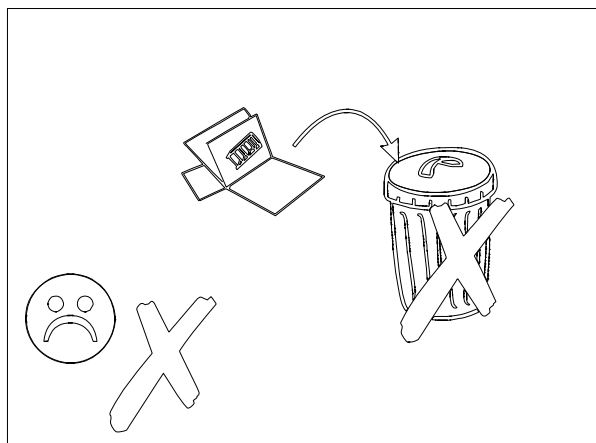
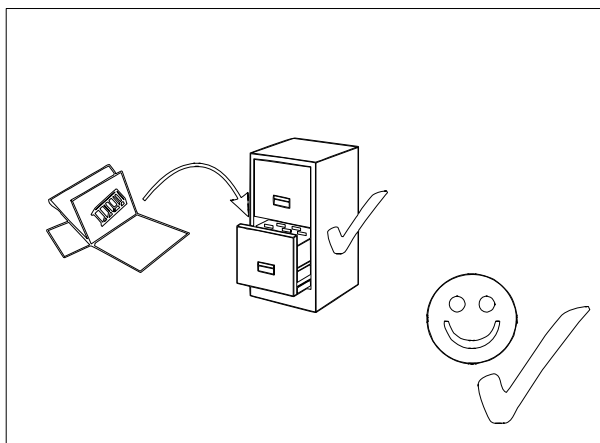
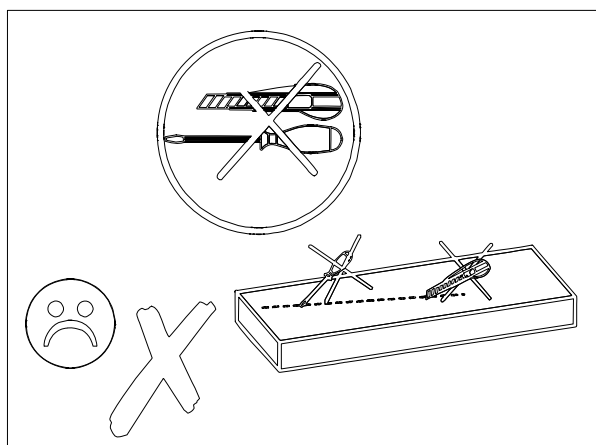
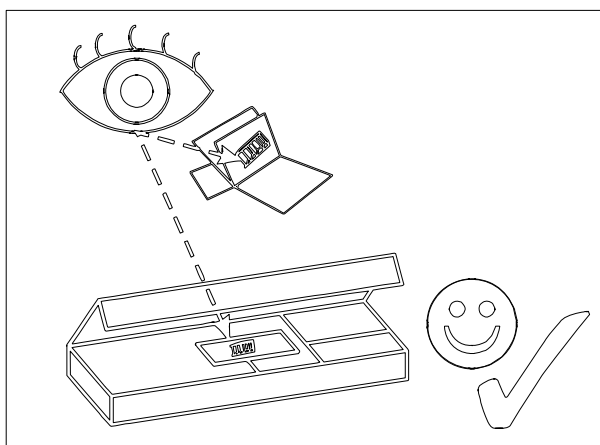

QUADRATTO / KOMODA 4SZ 1D

ZESTAW AKCESORIÓW (PACZKA) QUADRATTO / KOMODA 6SZ										SPR.	
KARTON 3/3											
K1	KOLEK Ø 8 60-SZT.	Z1	ZAŚLEPKA 18-SZT.	T1	TRZPIEŃ 44-SZT.	M1	MIMOŚRÓD 44-SZT.	G1	GWOŹDZIK 36-SZT.	E1	WZMOCNIENIE DO PLECÓW 16-SZT.
W1	EURO WKREŃ 32-SZT.	K2	BOLEC PÓLKI 4-SZT.	T2	ŚRUBA M6x45 8-SZT.	W3	WKREŃ 3.5x16 8-SZT.	W4	WKREŃ 4x30 4-SZT.	Ł2	NAKRĘTKA M6 + PODKŁADKA 8-SZT.

AKCESORIA DODATKOWE QUADRATTO / KOMODA 6SZ										SPR.	
KARTON 3/3											
P1	PROWADNICA FEV 360-MN. EXCEL 4-KPL.	D1	NOGA 100x80 4-SZT./KPL.	N2	NOGA H-100 1-SZT.	ZESTAW Z INSTR. ZAPOBIEGAJĄCY WYWRÓCENIU 1-KPL.		B2	ZAWIAS HETTICH 2-SZT.	O1	PROWADNIK Z EURO 2-KPL.
	INSTRUKCJA	I1	TIP-ON 956.1004 ADAPTER 956. 1201 PROSTY 1-KPL.	X1	LISTWA DO PLECÓW 745-MM 1-SZT.						

QUADRATTO / KOMODA 4SZ 1D

NR.	NAZWA	ELENTY WYM.	SZT.	WARSTWA	KARTON #3	SPRAWDZIŁ
1A	TOP GORA	#32x1600x410	1	1A	WYM. 1640x450x85 1/3	NR. PAKOWACZA
2A	TOP DOLNY	#32x1600x410	1	2A		
3A	BOK WEWN. PR	#16x736x368	1	3A		
4A	BOK WEWN. LE	#16x736x368	1	3A		
1B	BOK ŚRODK SZUFL PL	#16x165,5x368	2	4A	WYM. 800x430x120 2/3	NR. PAKOWACZA
2B	TYŁ SZUFL 1	#16x950x207	2	5A		
3B	BOK SZUFL 1	#16x350x221	4	6A		
4B	TYŁ SZUFL 2	#16x950x109	1	5A		
5B	BOK SZUFL 2_3	#16x350x124	4	6A		
6B	TYŁ SZUFL 3	#16x438x109	2	5A		
7B	PÓŁKA RUCH.	#16x515x350	1	6A		
1C	PLECY	#3x747x775	2	3A	WYM. 780x860x140 3/3	NR. PAKOWACZA
2C	BOK PRAWY	#32x736x410	1	2A		
3C	BOK LEWY	#32x736x410	1	2A		
4C	FRONT SZUFL. 32	#32x1020x163.5	1	4A		
5C	FRONT SZUFL. 18	#18x1020x280	2	4A		
6C	FRONT SZUFL. M. 18	#18x508x163.5	1	4A		
7C	PRZEPONA	#16x515x368	1	6A		
8C	DNO SZUFL M	#3x453x355	1	4B		
9C	DNO SZUFL D	#3x965x355	3	4B		
10C	FRONT DRZWI	#32x563.5x508	1	4B		
11C	NOGI	#42x80x100	4	4B		

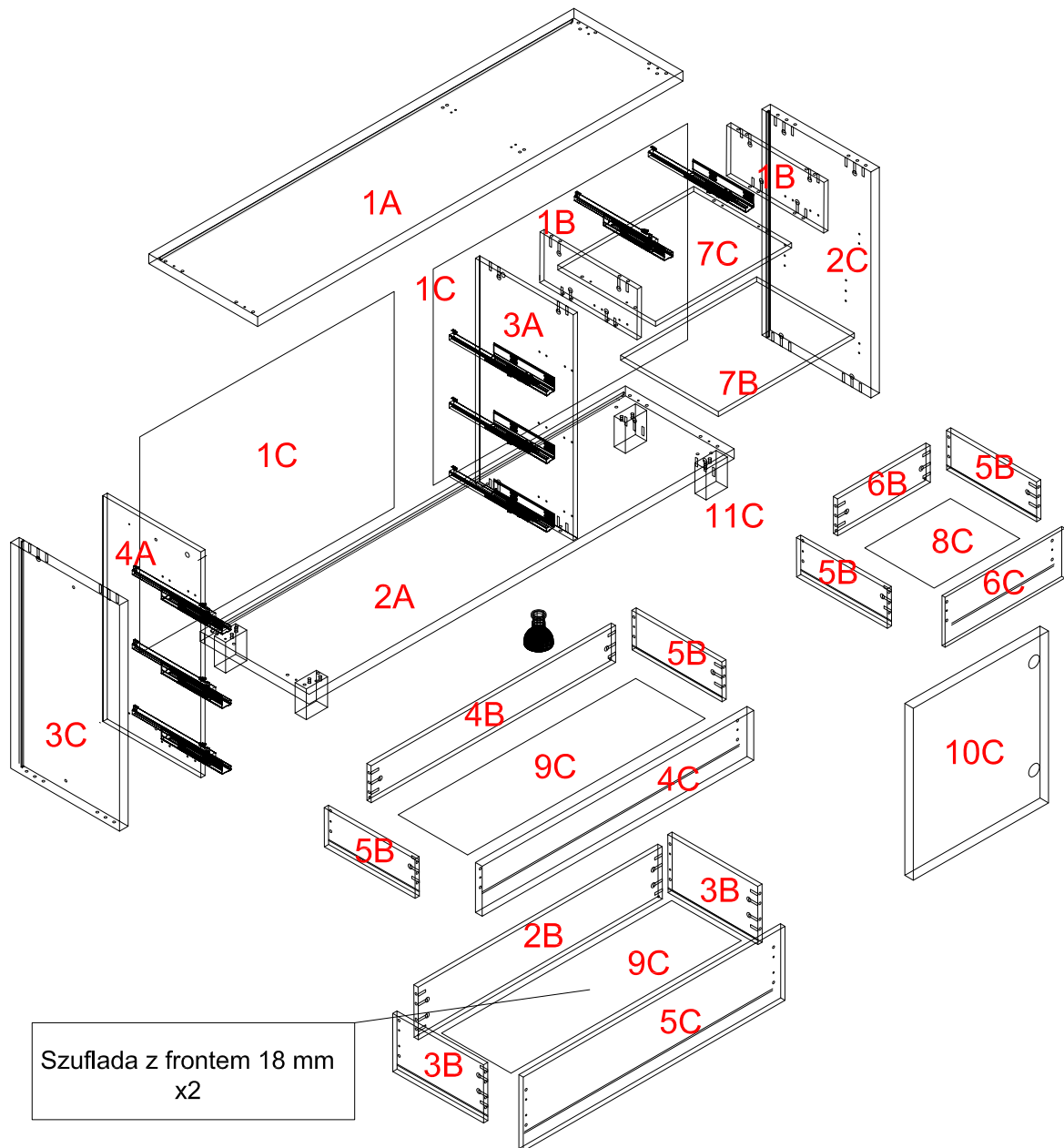

QUADRATTO / KOMODA 4SZ 1D

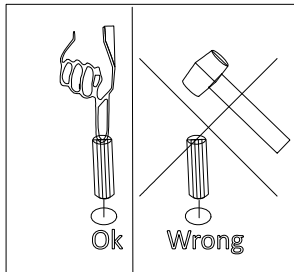
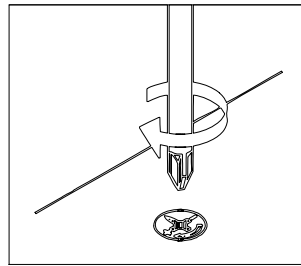
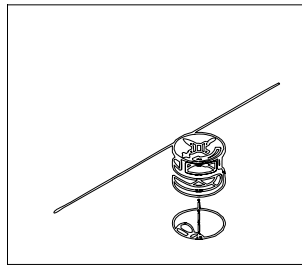
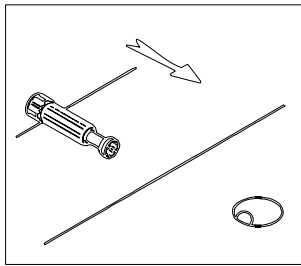
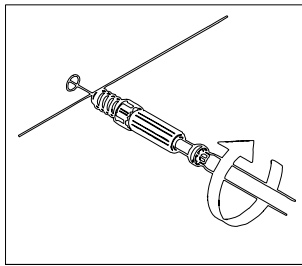

JEŚLI NOGI METALOWE
STOSOWAĆ ŁĄCZNIK Ł2
4 KPL.

F1
x8

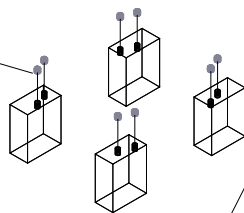

K1
x8

T1
x4

K1
x4

T1
x4

K1
x12

T1
x10

T2
x8

K1
x8

2A

1A

N2
x1

W3
x4

2A

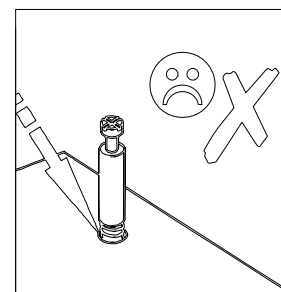
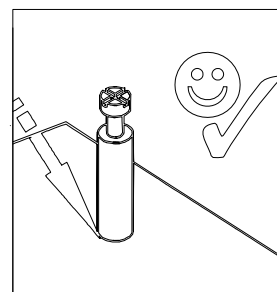

QUADRATTO / KOMODA 4SZ 1D

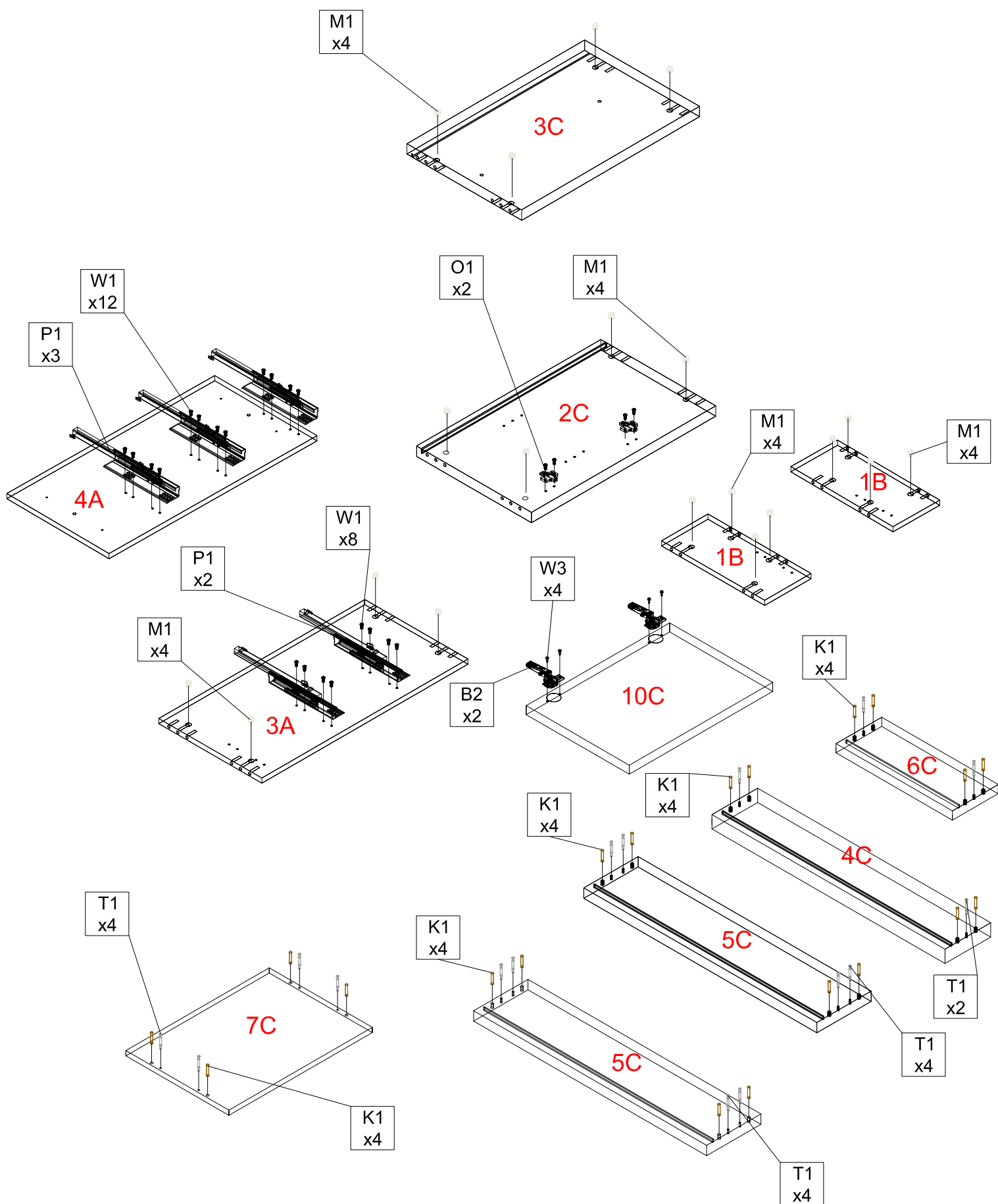

QUADRATTO / KOMODA 4SZ 1D

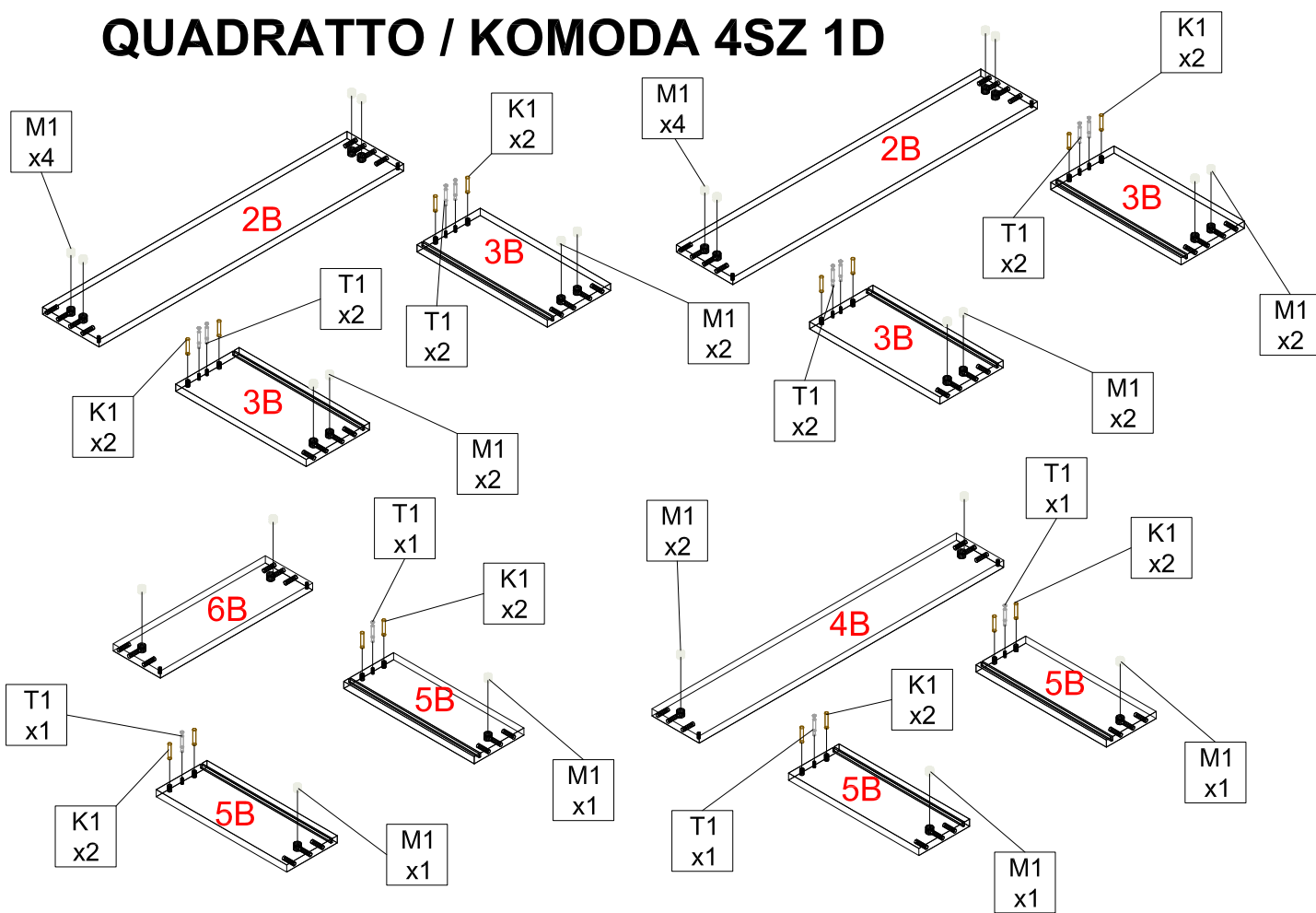

PONIŻSZE CZYNNOŚCI
POWTÓRZYĆ 4 RAZY

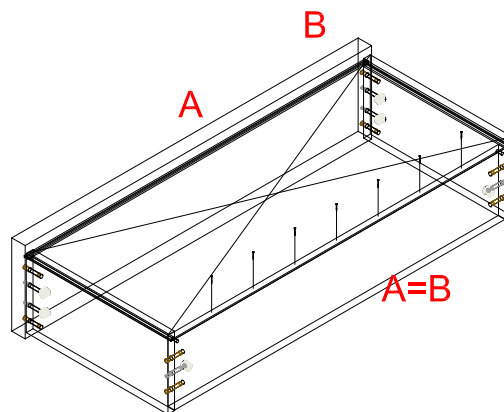
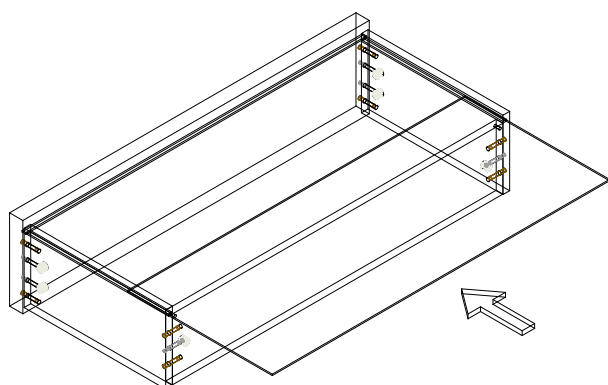
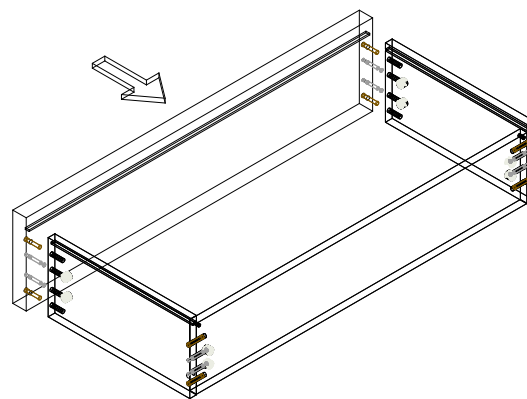
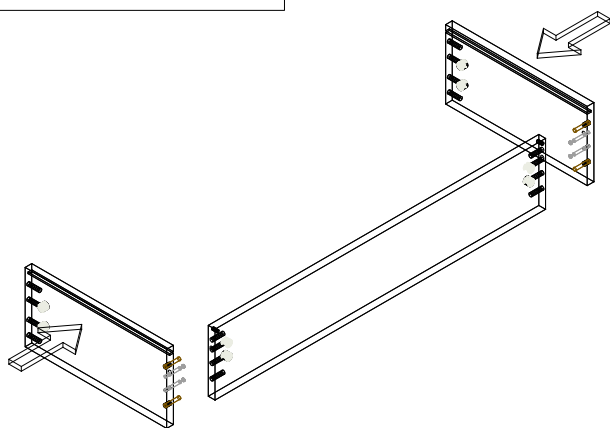

QUADRATTO / KOMODA 4SZ 1D

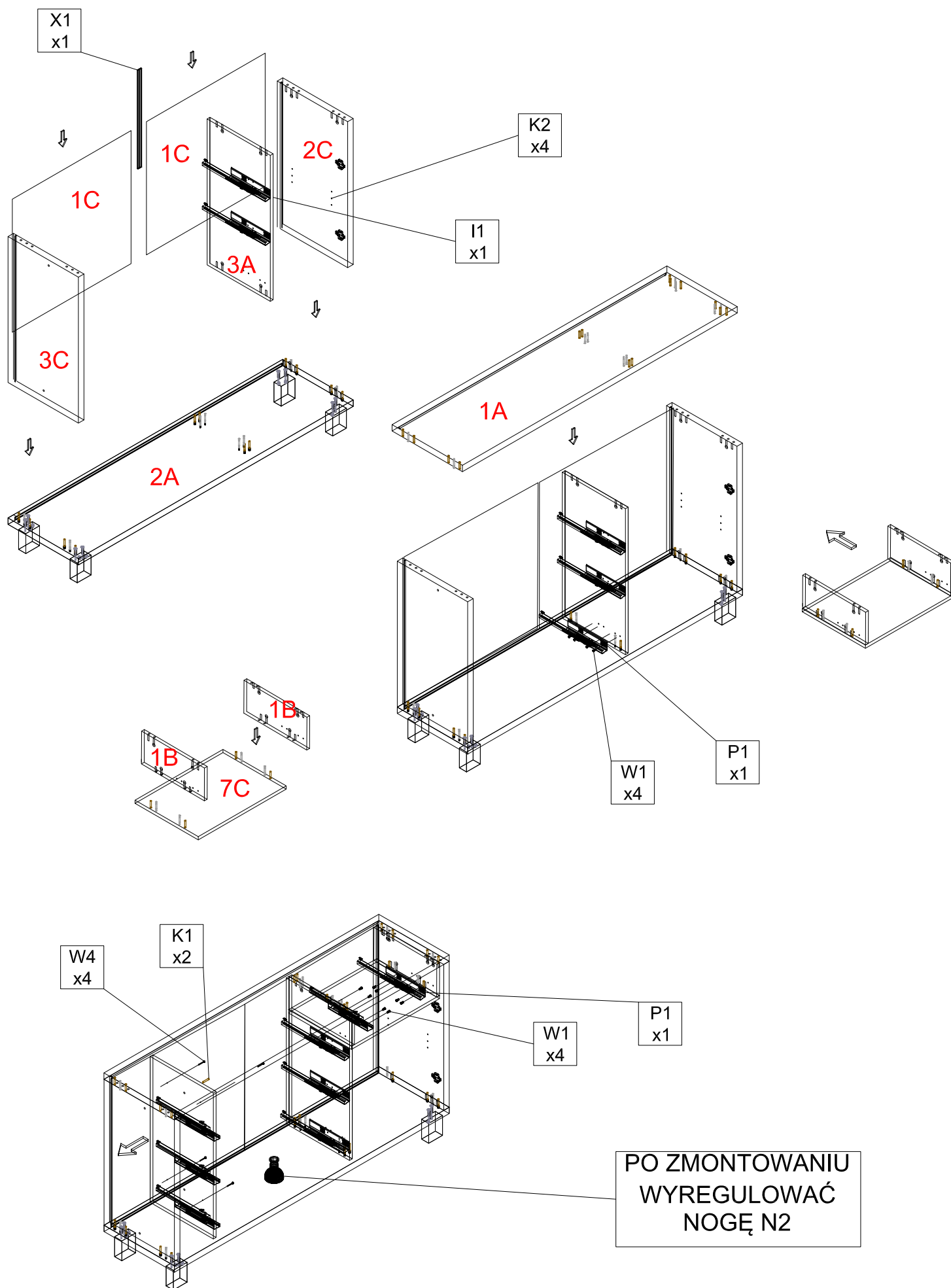

QUADRATTO / KOMODA 4SZ 1D

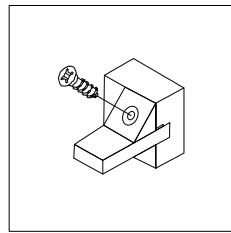
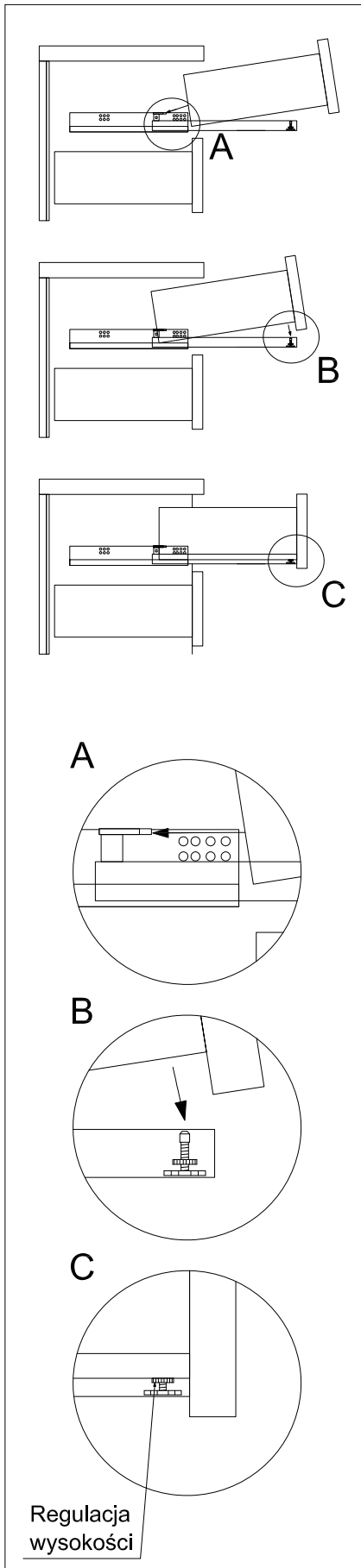

G1
x12

E1
x16

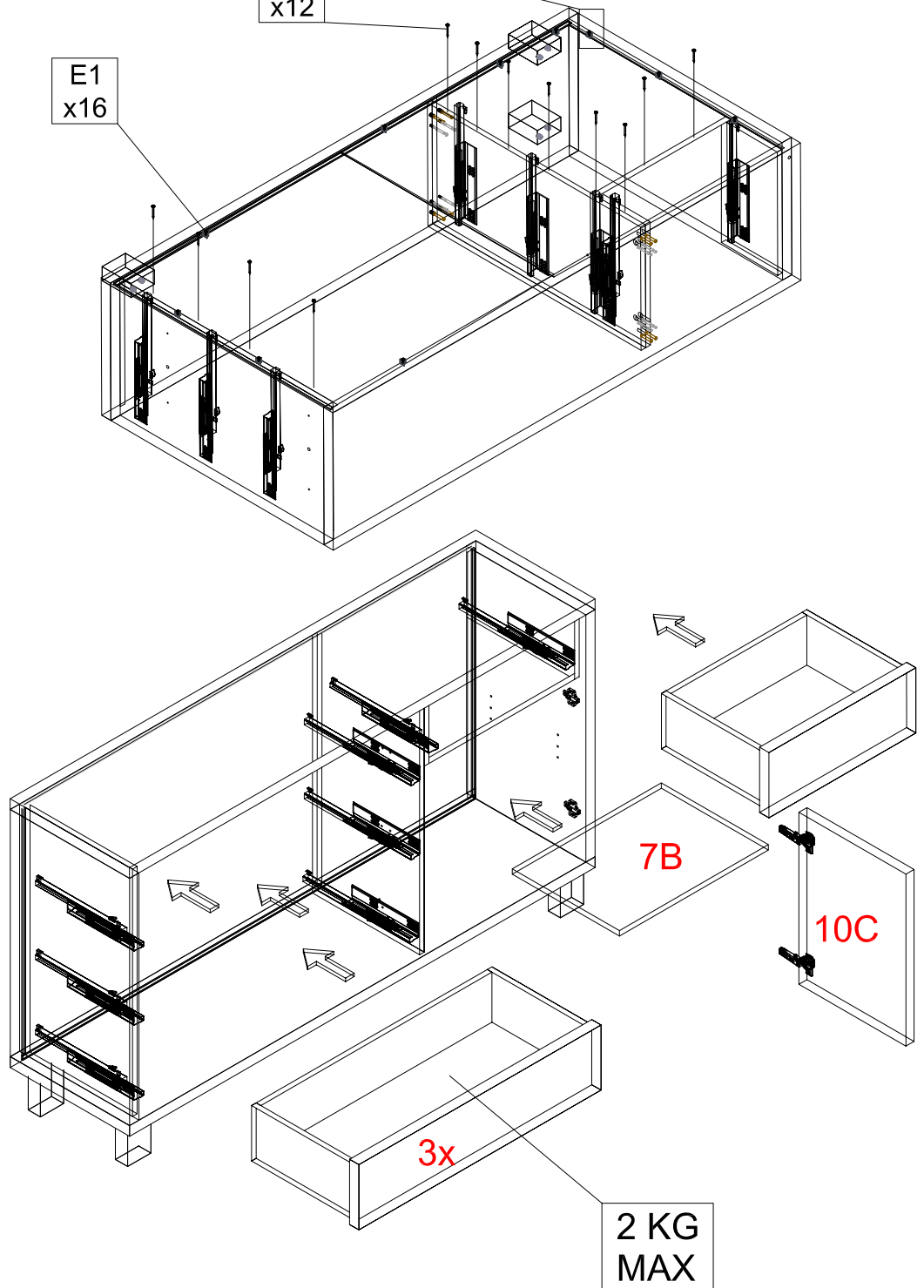
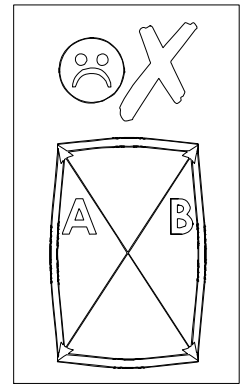
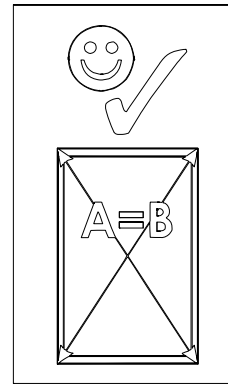

QUADRATTO / KOMODA 4SZ 1D

