

QUADRATTO / REGAŁ WYSOKI

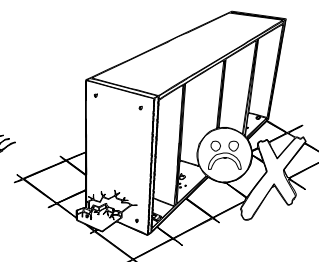

QUADRATTO / REGAŁ WYSOKI

PROSIMY O UWAGNE PRZECZYTANIE PRZED ROZPOCZĘCIEM MONTAŻU

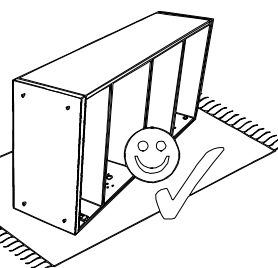
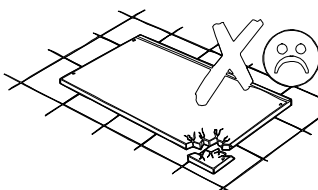
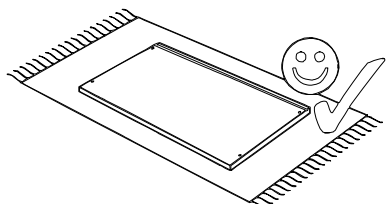
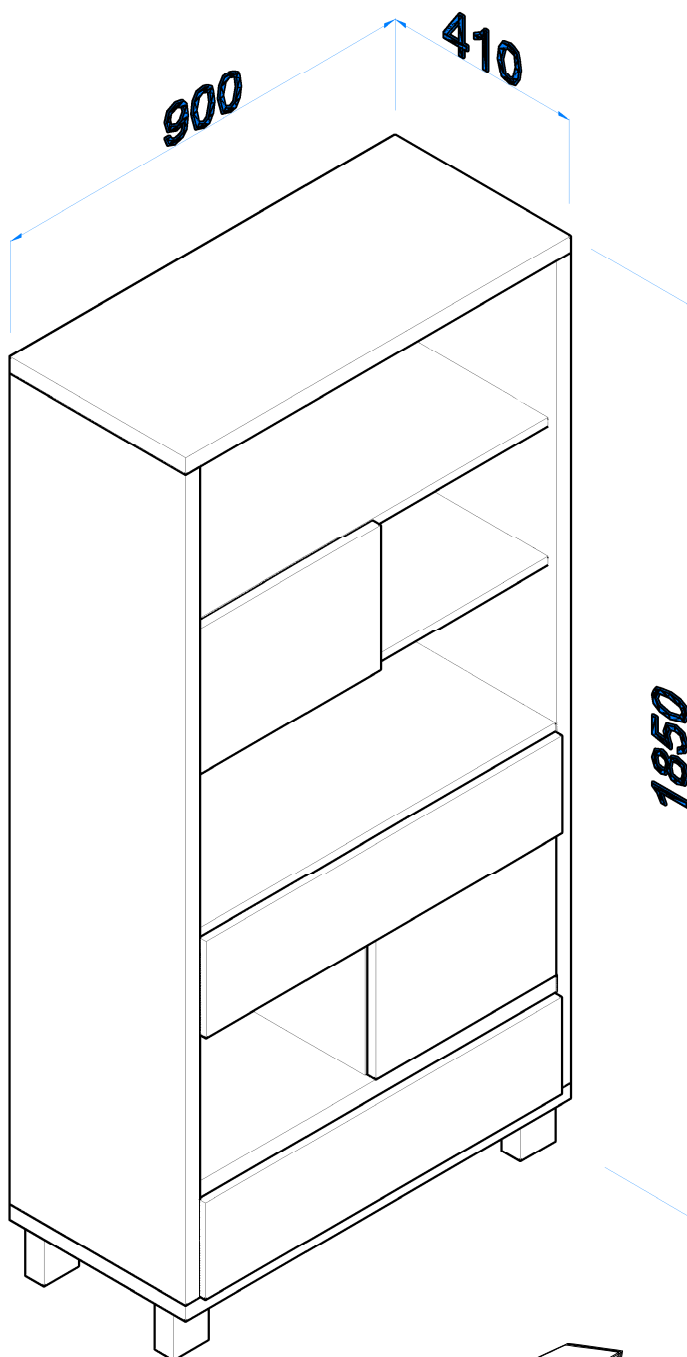
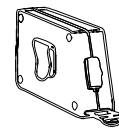
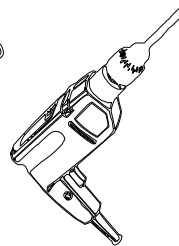
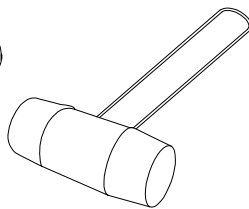
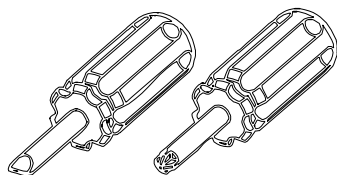
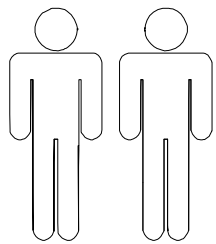





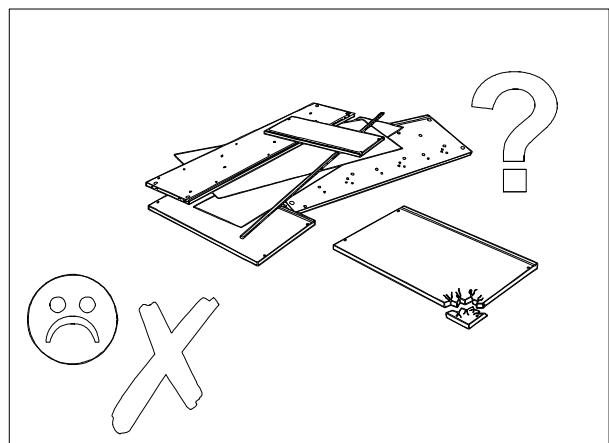
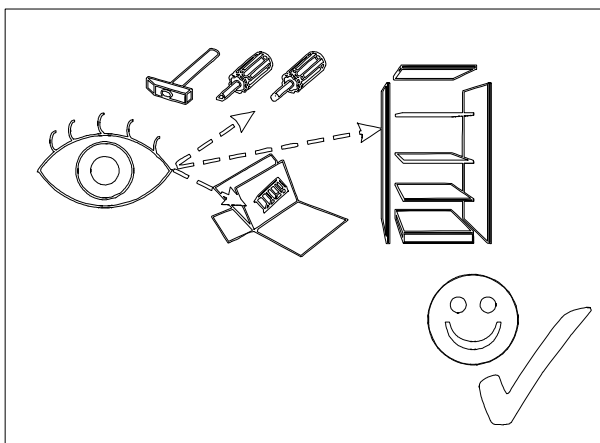
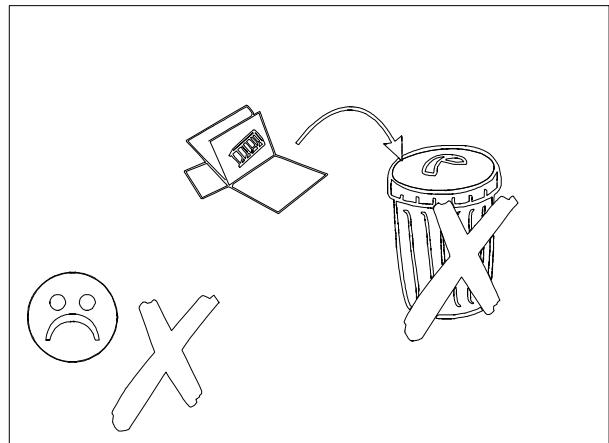
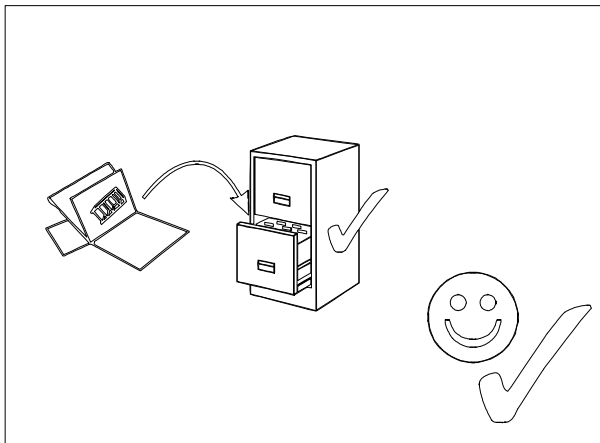
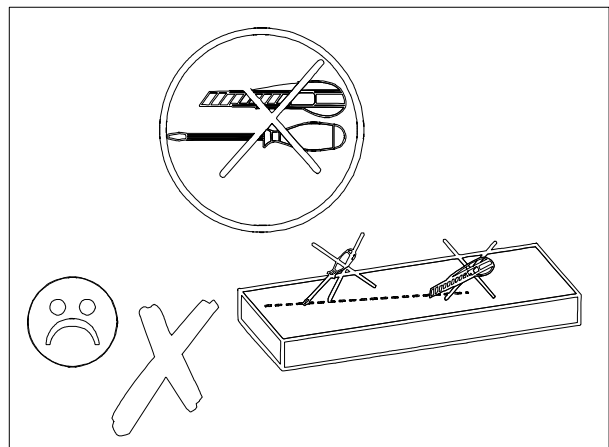
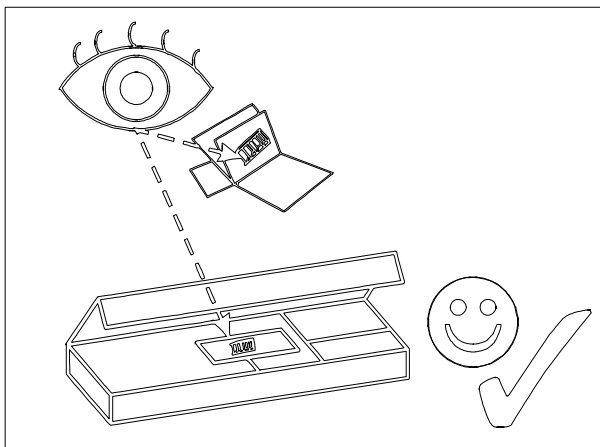

- Przed rozpoczęciem montażu mebli prosimy o szczegółowe zapoznanie się z instrukcją montażu i wykazem elementów wchodzących w skład danej paczki. W przypadku jakichkolwiek wątpliwości co do montażu zakupionych elementów prosimy o kontakt z salonem sprzedaży.
- W przypadku stwierdzenia jakichkolwiek braków w czasie rozpakowywania elementów, prosimy o skierowanie się do salonu z dowodem zakupu tegoż mebla oraz kartką kontrolną - etykietą z paczki, w której znajduje się dany element.
- W przypadku stwierdzenia uszkodzeń mechanicznych prosimy o nie montowanie mebla, udanie się do salonu z dowodem zakupu oraz kompletną paczką z oryginalnym (nieuszkodzonym) opakowaniem danego elementu celem potwierdzenia, iż uszkodzenia nie powstały wskutek nieprawidłowego montażu lub rozpakowania.
- Elementy uszkodzone zmontowane, noszące znamiona rozpoczętego montażu lub dostarczone bez oryginalnego opakowania nie podlegają reklamacji.
- Wszystkie uszkodzenia powstałe w wyniku nieprawidłowego montażu mebli przez klienta są traktowane jako reklamacje odpłatne.
- Zgłoszenia reklamacji należy dokonywać w formie pisemnej z wyszczególnieniem: opisu uszkodzenia, data i numer dowodu zakupu, numeru pakowacza (znajdującego się na etykiecie kontrolnej).
- Zarówno opakowania plastikowe, jak i okucia trzymać w miejscu niedostępnym dla niemowląt i dzieci.
- Wszystkie połączenia powinny być odpowiednio dokręcone

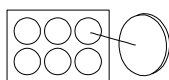
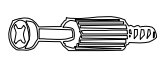

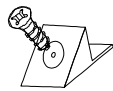
READ BEFORE ASSEMBLY

- Please read entirely Included Instruction manual and review packaged accessories according to diagram before assembling your furniture. Should you need further assistance with assembly, please contact your original place of purchase.
- Should you find missing parts or accessories during unpacking, please contact your original place of purchase. Have your original sales receipt and particular box control label ready.
- Should you find your furniture mechanically damaged, please do not continue with assembly. Return the product to original place of purchase along with all packaging materials in order to verify, that damages were caused during shipment and to improper assembly or unpacking.
- Any assembled and partially assembled units returned without original packaging will not be warranted.
- Any claims due to damages arisen during improper assembly by end user, or a third party will be covered for a fee.
- All claims must be submitted in writing only including the following: name, address, contact, detailed description of damages, proof of purchase and box control label (which includes ID number of packing person).

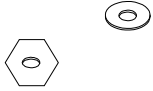

QUADRATTO / REGAŁ WYSOKI

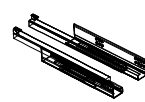
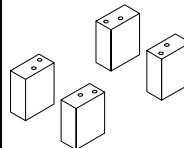
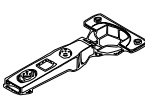
ZESTAW AKCESORIÓW (PACZKA) QUADRATTO / REGAŁ WYSOKI										SPR.	
KARTON 1/3											
											
K1	KOLEK Ø 8 88-SZT.	Z1	ZASLEPKA 40-SZT.	T1	TRZPIEŃ 40-SZT.	M1	MIMOŚRÓD 40-SZT.	G1	GWOŹDZIK 33-SZT.	E1	WZMOCNIENIE DO PLECÓW 16-SZT.
											
W1	EURO WKREŃ 16-SZT.	F1	MUFA M6x12 8-SZT.	T2	ŚRUBA M6x45 8-SZT.	W3	WKREŃ 3.5x16 8-SZT.	X1	LISTWA DO PLECÓW 1690-MM 1-SZT.	Ł2	NAKRETKAM6 +PODKŁADKA 8-SZT.

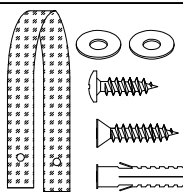
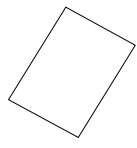
AKCESORIA DODATKOWE QUADRATTO / REGAŁ WYSOKI										SPR.	
KARTON 1/3											
											
P1	PROWADNICA FEV 360-MN. EXCEL 2-KPL.	D1	NOGA 100x80 4-SZT./KPL.	B2	ZAWIAS GTV B025 4-SZT.	O1	PROWADNIK GTV Z EURO 4-KPL.	I1	TIP-ON 956.1004 ADAPTER 956. 1201 PROSTY 2-KPL.	ZESTAW Z INSTR. ZAPOBIEGAJĄCY WYWRÓCENIU 1-KPL.	
											
	INSTRUKCJA										

QUADRATTO / REGAŁ WYSOKI

NR.	NAZWA	ELENTY WYM.	SZT.	WARSTWA	KARTON #3	SPRAWDZIŁ
1A	BOK LEWY	#32x1686x410	1	3A-3A	1	WYM. 1750x470x70 1/3
2A	BOK PRAWY	#32x1686x410	1	1A	2	
3A	PLECY	#3x1702x425	2	2A	3	
9C	DNO SZUFL	#3x809x355	2	9C-9C	9	
1B	TOP GÓRNY	#32x900x410	1	1B	1	WYM. 950x460x130 2/3
2B	TOP DOLNY	#32x900x410	1	2B	2	
3B	PRZEPONA 32	#32x836x389	1	3B	3	
3C	PRZEPONA 3	#16x836x388	1	2C	3	
1C	PRZEPONA 4	#16x836x370	1	3C	1	
5B	FRONT SZUFL 2	#32x832x194	1	6B-6B	5	WYM. 890x450x140 3/3
2C	PRZEPONA 5	#16x836x370	1	1C	2	
4B	FRONT SZUFL 1	#32x832x194	1	4B-5B	4	
4C	PRZEPONA 2	#16x836x368	1	4C	4	
5C	PRZEGRODA PION D.	#16x368x268	1	8C-11C	5	
6C	PRZEGRODA PION G.	#16x368x290.5	1	7C-7C	6	
1D	NOGI	#42x80x100	4			
6B	FRONT DRZWI	#18x421x294	2			
10C	BOK SZUFL	#16x340x149	4			
11C	TYŁ SZUFL	#16x794x135	2			

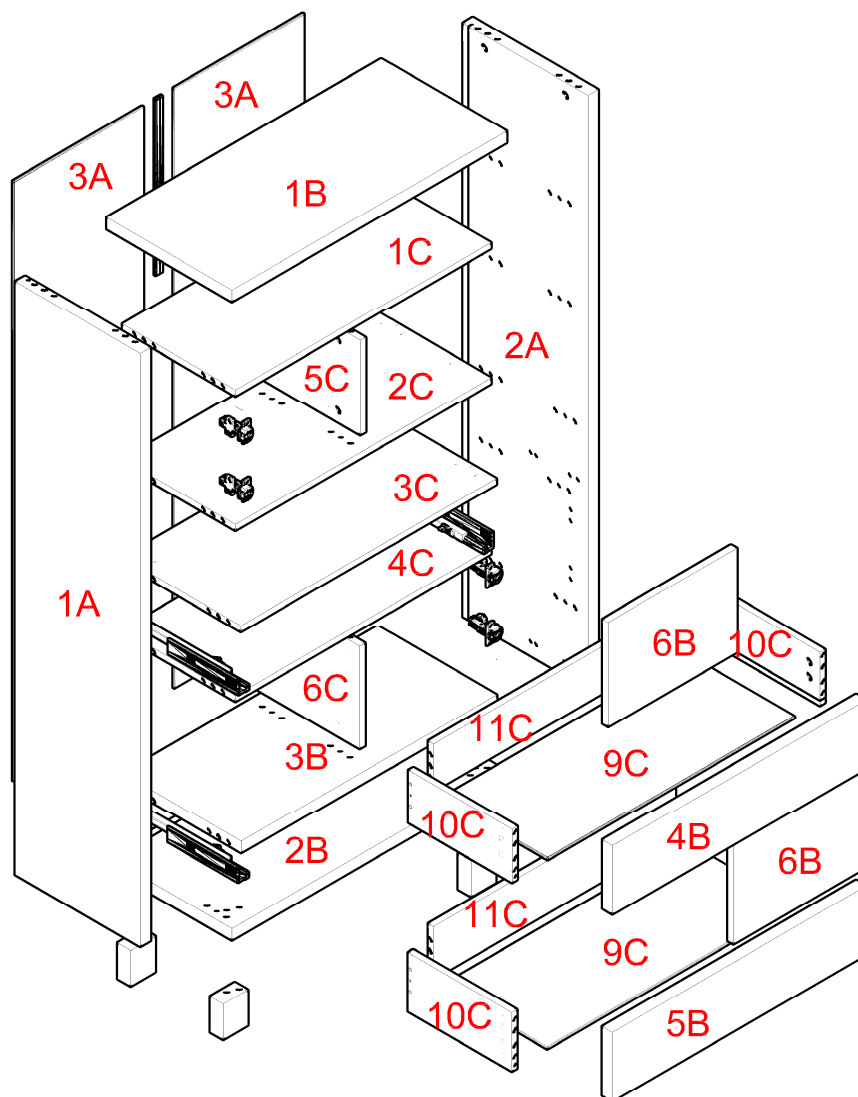

QUADRATTO / REGAŁ WYSOKI

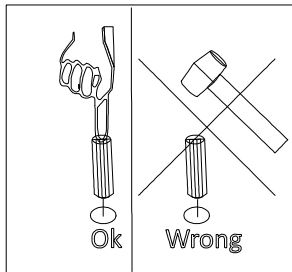
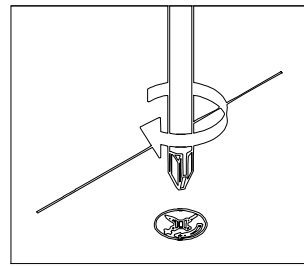
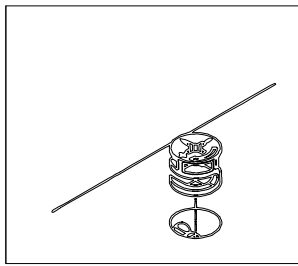
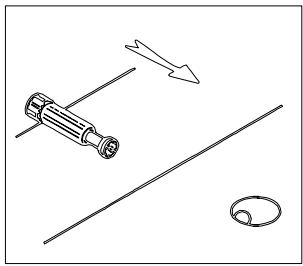
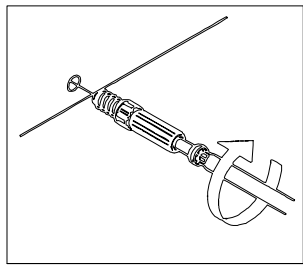

JEŚLI QUADRATTO GRAPHITE STOSOWAĆ ŁĄCZNIK Ł2 x8

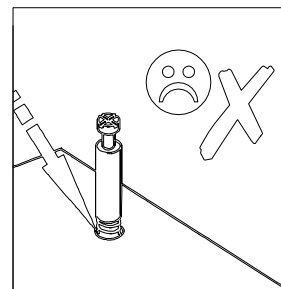
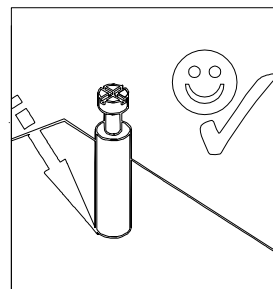
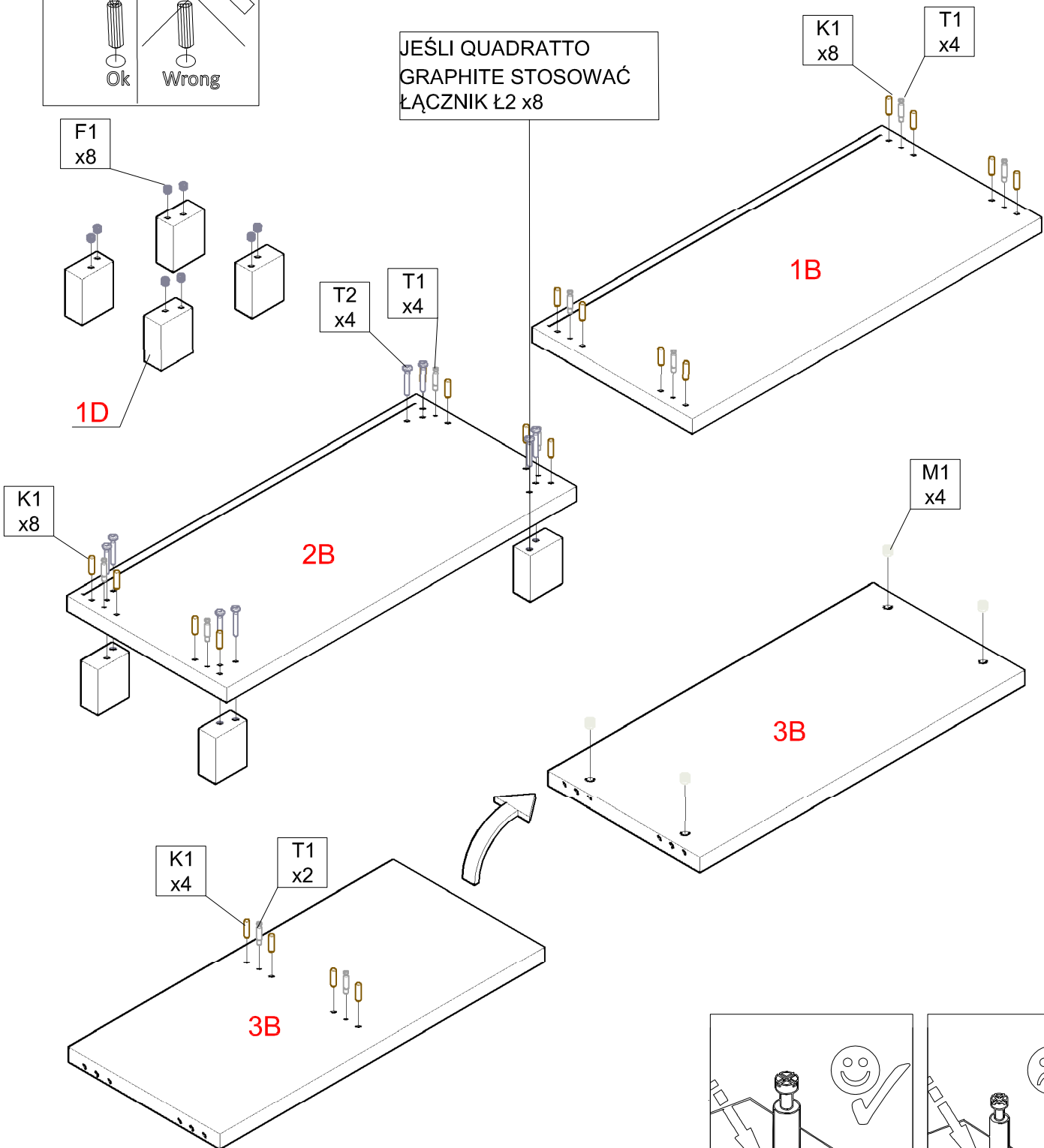

QUADRATTO / REGAŁ WYSOKI

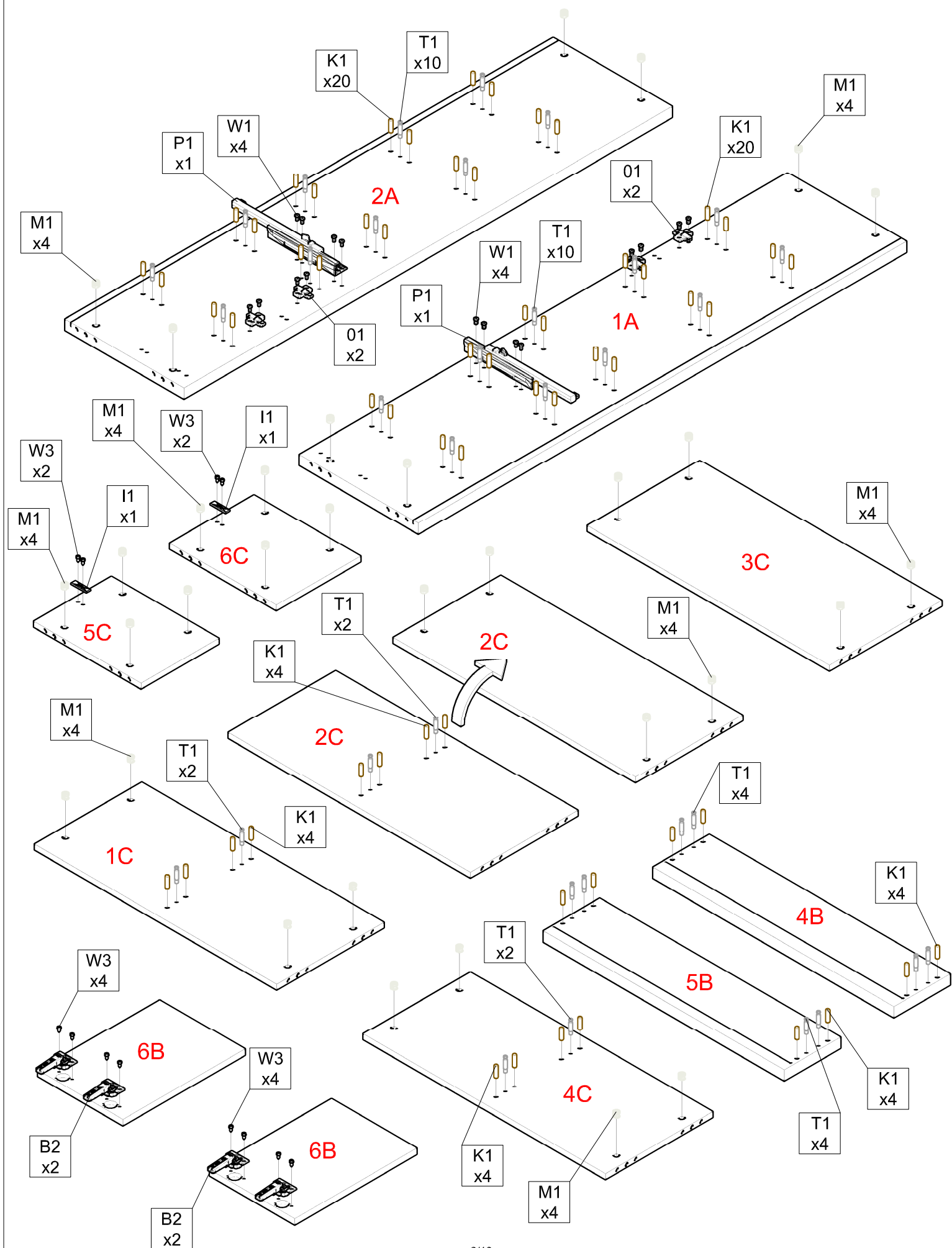

QUADRATTO / REGAŁ WYSOKI

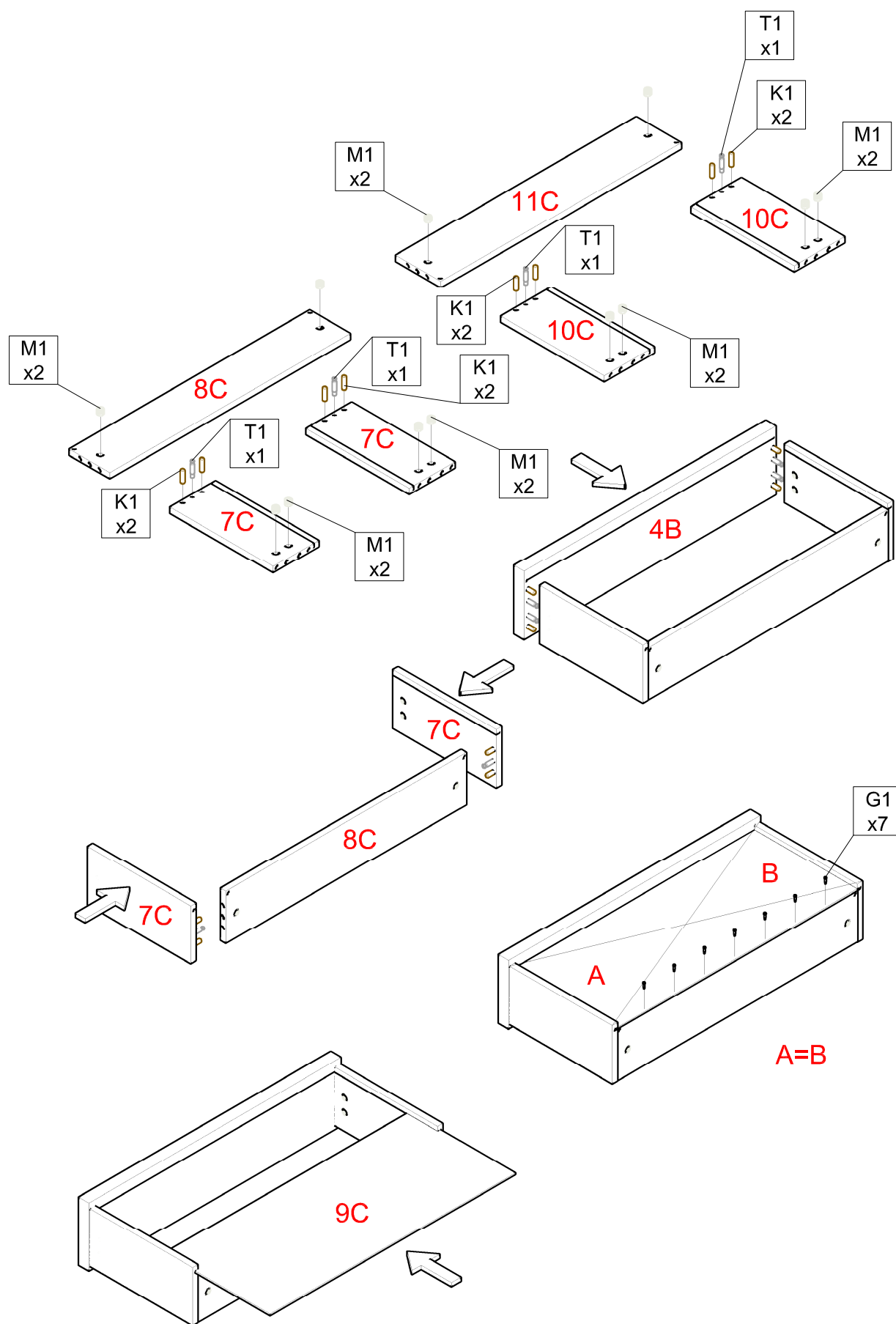

QUADRATTO / REGAŁ WYSOKI

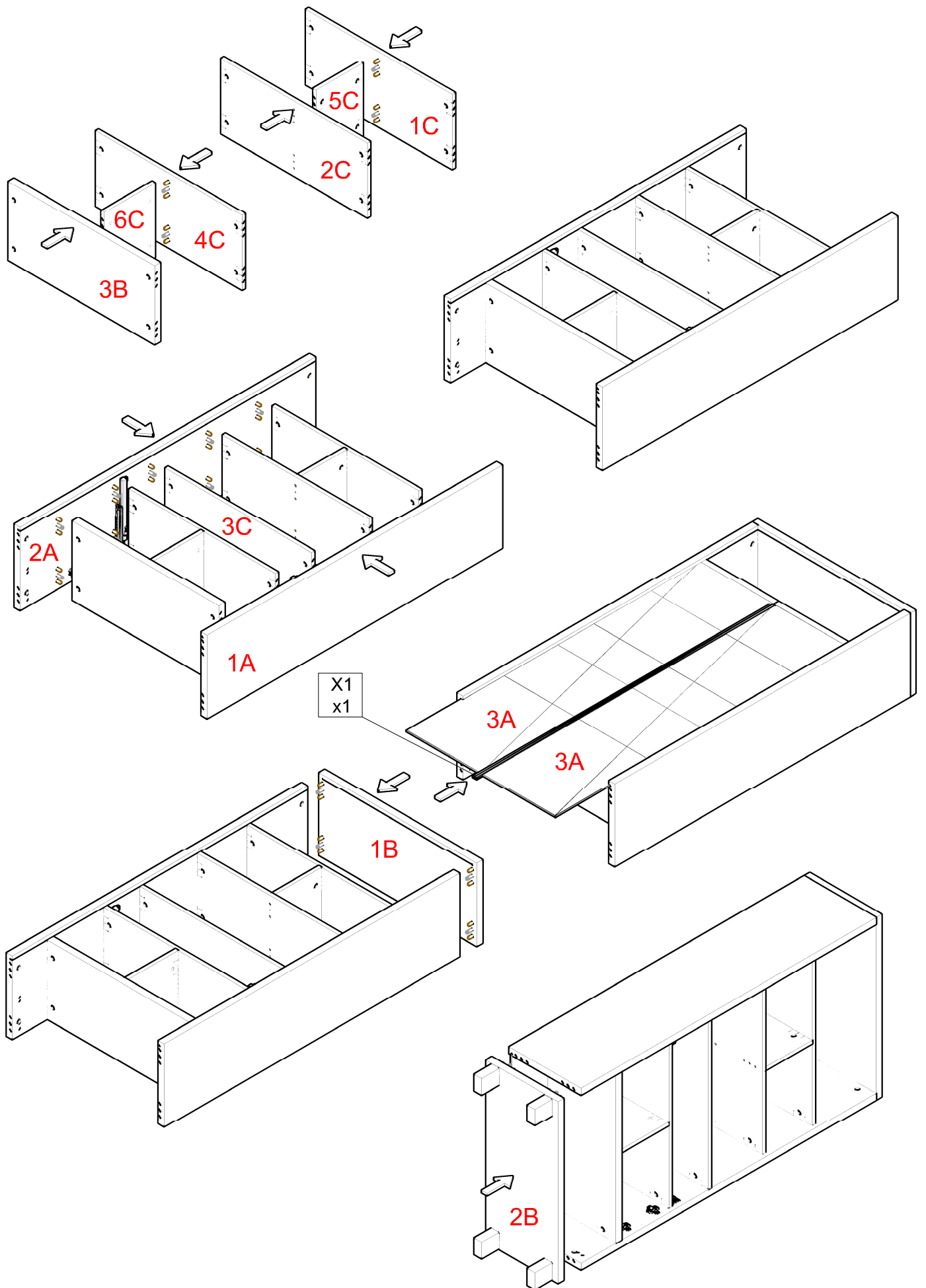

QUADRATTO / REGAŁ WYSOKI

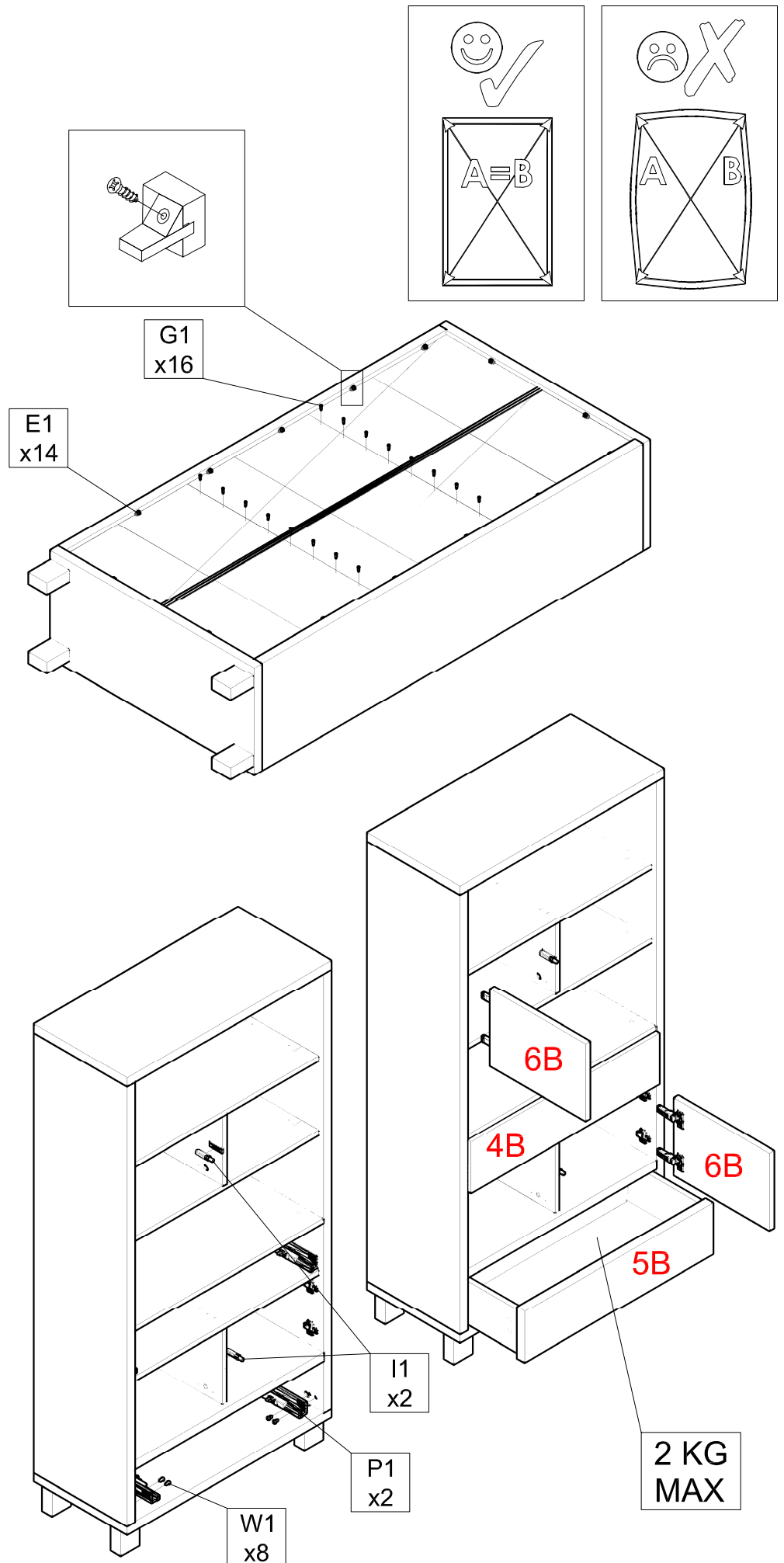
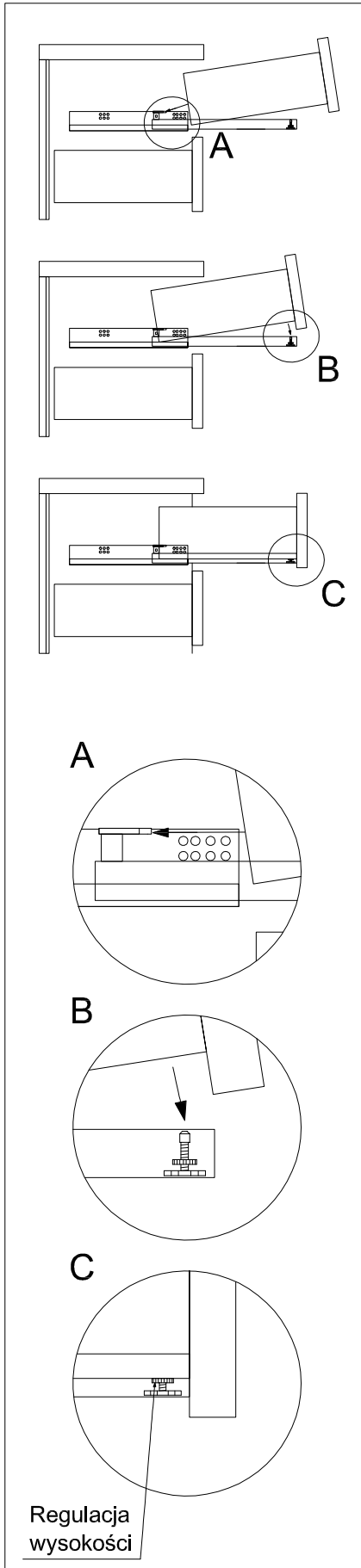

QUADRATTO / REGAŁ WYSOKI

